



# GigaVUE-HC1-PLUS Hardware Installation Guide

**GigaVUE HC Series**

Product Version: 6.9

Document Version: 1.0

(See Change Notes for document updates.)

**Copyright 2024 Gigamon Inc. All rights reserved.**

Information in this document is subject to change without notice. The software described in this document is furnished under a license agreement or nondisclosure agreement. No part of this publication may be reproduced, transcribed, translated into any language, stored in a retrieval system, or transmitted in any form or any means without the written permission of Gigamon Inc.

**Trademark Attributions**

Gigamon and the Gigamon logo are trademarks of Gigamon in the United States and/or other countries. Gigamon trademarks can be found at [www.gigamon.com/legal-trademarks](http://www.gigamon.com/legal-trademarks). All other trademarks are the trademarks of their respective owners.

Gigamon Inc.  
3300 Olcott Street  
Santa Clara, CA 95054  
408.831.4000

# Change Notes

When a document is updated, the document version number on the cover page will indicate a new version and will provide a link to this Change Notes table, which will describe the updates.

Product Version	Document Version	Date Updated	Change Notes
6.9	1.0	12/06/2024	The original release of this document with 6.9 GA.

# Contents

<b>GigaVUE-HC1-PLUS Hardware Installation Guide</b> .....	<b>1</b>
Change Notes .....	3
Contents .....	4
<b>GigaVUE-HC1-Plus Overview</b> .....	<b>8</b>
<b>Introducing the GigaVUE-HC1-Plus Chassis</b> .....	<b>8</b>
Hardware Root of Trust (HROt) .....	10
Dual BIOS Image .....	11
Chassis Cooling .....	11
Air Flow Direction .....	14
AC- and DC-Powered GigaVUE-HC1-Plus .....	14
Breakout Panels .....	14
<b>GigaVUE-HC1-Plus Base Chassis</b> .....	<b>15</b>
Port Numbering .....	15
Module Status LEDs .....	16
System LED .....	16
PSU Led .....	16
Management Port LED .....	17
Fan Status LED .....	17
Base Chassis Port Status LEDs .....	17
<b>GigaVUE-HC1-Plus Modules</b> .....	<b>17</b>
Bypass Modules (BPS-HC1-D25A60 SX/SR, BPS-HC1-D35C60 LX/LR) .....	18
Module Status LEDs .....	20
Inline Network Ports .....	20
SMT-HC1A-R .....	21
PRT-HC1-Q04X08 Module .....	21
Features .....	21
Module LEDs .....	22
Port Status LEDs .....	22
SMT-HC1-S (Gen 3 GigaSMART Card) .....	22
Ports and LEDs .....	23
PRT-HC1-X12 Module .....	23
BPS-HC1-D25A24 Bypass Combo Module .....	24
Bypass Combo Modules .....	24
Features of the 10Gb Bypass Combo Module .....	25

- Module Status LEDs .....25
- Port Status LEDs .....26
- Ports .....26
- Inline Network Ports .....26
- TAP-HC1-G10040 Module .....26**
  - Using the TAP-HC1-G10040 Module for Copper Bypass ..... 27
  - Using TAP-HC1-G10040 Module for Gigamon Resiliency for Inline Protection .....27
- Upgrading PLDs .....28**
- GigaVUE-HC1-Plus Installation Roadmap .....28**
  - First Steps – Getting Unpacked, Racked, Installed and Connected ..... 29
  - Next Steps ..... 30
- Assembling the GigaVUE-HC1-Plus Node .....31**
  - Unpacking the GigaVUE-HC1-Plus Shipment ..... 31
- Rack-Mounting the GigaVUE-HC1-Plus Chassis .....32**
  - Safety Precautions .....32
  - Rack-Mounting on GigaVUE-HC1-Plus .....32
  - Four-Post Rack Mounting ..... 33
- Installing and Removing Modules Procedure .....34**
  - Hot Swapping Modules .....34
  - Module Installation Procedure .....34
- Module Removal and Replacement Procedure (Hot Removal) .....35**
  - Replacing a Module with the Same Type of Module ..... 35
  - Replacing a Module with a Different Type of Module ..... 36
  - Fan Replacement Procedure .....36
  - Next Steps ..... 36
- Basic GigaVUE® HC series Connections and Configuration .....36**
  - Grounding the GigaVUE-HC1-Plus Chassis ..... 37
  - Connecting Power to the GigaVUE-HC1-Plus .....38
  - Removing a Power Supply Module .....39
  - Connecting -48V DC Power Supply Modules .....39
- Connecting Serial Console and Mgmt Ports .....40**
- Configuring Basic GigaVUE® HC series Settings .....41**
  - Access the Command-Line Interface over the Console Port ..... 41
    - Run the Jump-Start Script ..... 43
    - Need to Change Any Settings? .....44
  - Configure Modules and Enable Ports ..... 45

Command-Line Basics .....	46
Command-Line Modes .....	47
Differences in Commands for admin and default Level Users .....	47
Entering Commands in the CLI .....	49
Command-Line Syntax – Entering Commands .....	50
Configure Mode Syntax .....	50
Paging through CLI Output .....	51
<b>Command-Line Syntax – Entering Commands .....</b>	<b>52</b>
Configure Mode Syntax .....	53
Paging through CLI Output .....	53
The Basic Commands .....	54
<b>Completing the Initial GigaVUE® HC series Setup .....</b>	<b>58</b>
<b>Enter the Configure Command-Line Mode .....</b>	<b>58</b>
<b>SSH .....</b>	<b>59</b>
Advantages of SSH2 .....	59
Verifying Host Keys During Connection .....	59
Changing Host Keys .....	60
Connecting to the GigaVUE® HC series Node from GigaVUE-FM .....	60
Next Steps? .....	61
Configuring GigaVUE® HC series Time Options .....	61
Setting Time Manually .....	62
Performing One-Time NTP Server Synchronization .....	62
Using NTP Time Server for Clock Synchronization .....	62
Configuring Automatic Email Notifications .....	63
Using a Custom Banner .....	65
Saving Changes .....	65
<b>Connecting GigaVUE-HC1-Plus Ports .....</b>	<b>66</b>
Transceiver—Rules and Notes .....	67
Transceiver Installation Instructions .....	67
Installing Transceivers .....	67
Removing Transceivers .....	67
<b>Copper TAP Specifications .....</b>	<b>68</b>
<b>Bypass Module Specifications .....</b>	<b>68</b>
<b>Connecting GigaVUE-HC1-Plus Module Ports .....</b>	<b>69</b>
Enabling Modules and Ports .....	69
Setting Port Parameters Manually .....	71
Forcelinkup and Enabling/Disabling Ports .....	72
<b>GigaVUE-HC1-Plus Specifications .....</b>	<b>72</b>
Physical Dimensions and Weight .....	73
Battery Caution .....	73

Compliance .....	74
Safety .....	74
Emissions .....	74
Class A Information Technology Equipment (ITE) .....	74
Class A Korea Caution .....	74
Immunity .....	75
Environmental .....	75
Security .....	75
Power Requirements .....	75
Environmental Specifications .....	76
Standards and Protocols .....	76
Warranty .....	76
<b>Console Port Signaling and Cabling .....</b>	<b>77</b>
<b>NEBS Level 3 Compliance .....</b>	<b>78</b>
Installation Instructions GigaVUE-HCI-Plus .....	78
Intrabuilding or Intra-connection .....	78
Intrabuilding Ports (RJ45) .....	79
Class A2 Voltage Accessibility .....	79
Class B Voltage Accessibility .....	79
Equipment Grounding Systems .....	79
Communication Equipment Grounding .....	79
Connections .....	79
Maintenance .....	80
<b>Additional Sources of Information .....</b>	<b>81</b>
<b>Documentation .....</b>	<b>81</b>
How to Download Software and Release Notes from My Gigamon .....	84
<b>Documentation Feedback .....</b>	<b>84</b>
<b>Contact Technical Support .....</b>	<b>85</b>
<b>Contact Sales .....</b>	<b>86</b>
<b>Premium Support .....</b>	<b>86</b>
<b>The VÜE Community .....</b>	<b>86</b>
<b>Glossary .....</b>	<b>87</b>

# GigaVUE-HCI-Plus Overview

The GigaVUE-HCI-Plus is GigaVUE® HC series Deep Observability Pipeline node with a modular 1RU design. The base chassis includes 4 x 40Gb/100Gb and 8 x 1Gb/10Gb/25Gb connectivity and an embedded rear GigaSMART card to support licensed GigaSMART applications.

## GigaVUE-HCI-Plus

- **1RU Footprint**
- **Two Module Slots (Bays) and one Fixed Base Module**
- **Dual hot-pluggable power supplies (AC/DC)**
- **4x40Gb/100Gb, 8x1Gb/10Gb/25Gb connectivity**
- **Supports GigaSMART applications with a fixed embedded GigaSMART engine.**
- **Supports Flex Inline in unprotected ports with 10Gb/25Gb/40Gb/100Gb/4x10Gb/4x25Gb speed Nodes.**
- **Cluster with GigaVUE® HC series and GigaVUE TA Series.**
- **All ports, excluding BPS ports, of same type and speed can be used to create GigaStream.**

## GigaVUE-HCI-Plus

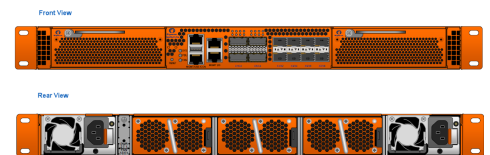

## Introducing the GigaVUE-HCI-Plus Chassis

The fully-assembled GigaVUE-HCI-Plus chassis consists of a 1RU, rack-mountable chassis with management, network, and tool ports at the front and power connections and fans at the rear. [Figure 1 Front View of GigaVUE-HCI-Plus Chassis](#) summarizes the bays and components at the front, and [Figure 2 Rear View of GigaVUE-HCI-Plus Chassis](#) summarizes the rear of the GigaVUE-HCI-Plus chassis.

**NOTE:** The CLI recognizes the MGMT port as eth0, the MGMT 2 port as eth2, and the MGMT 3 port as eth1.

**Figure 1** Front View of GigaVUE-HCI-Plus Chassis



Front View

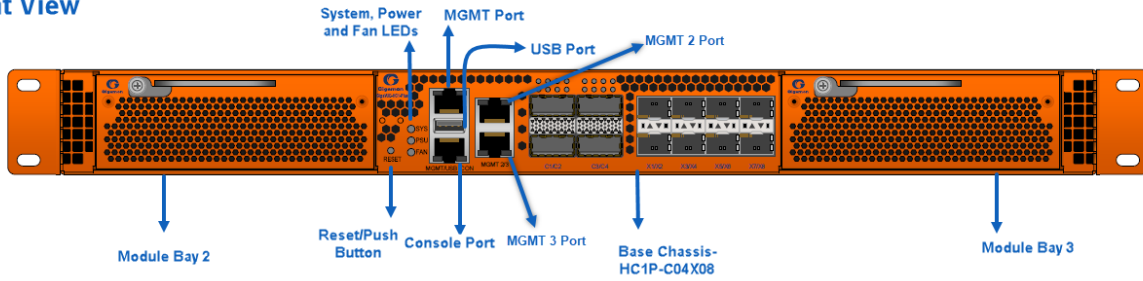
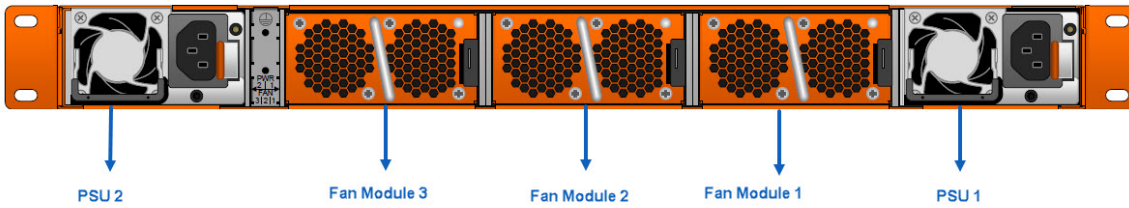

Figure 2 Rear View of GigaVUE-HC1P Chassis

Rear View



**NOTE:** The GigaVUE-HC1-Plus chassis ships from the factory with power supply modules and fans installed. The GigaVUE-HC1-Plus modules are shipped separately. Refer to [Unpacking the GigaVUE-HC1-Plus Shipment](#) for assembly instructions.

Table 1: GigaVUE-HC1-Plus Chassis Components

Front Components on the GigaVUE-HC1-Plus Chassis	
Module Bays	The base chassis is in the center and numbered 1. Slots (bays) are numbered 2-3 from left to right.
Base Chassis	<p>The GigaVUE-HC1-Plus includes a base chassis that holds the management and processing components installed inside the unit. It is located in the center of the front of the chassis.</p> <div style="border: 1px solid #ccc; padding: 5px; margin: 5px 0;"> <p><b>NOTE:</b> The base chassis is not hot-swappable.</p> </div> <p>The base chassis also controls the Mgmt port and console port on the front of the node for network and local administrative access to the GigaVUE-OS command-line interface (CLI). The base chassis provides 4x40Gb/100Gb and 8x1Gb/10Gb/25Gb support. The default port speed is 10Gb/100Gb, which is denoted by C/X.</p> <p>Every group of four ports (quad) can be configured as 25Gb. There cannot be a mix of 10Gb and 25Gb ports in one quad. By default, all eight ports are configured as 10Gb ports. To configure 25Gb, you must configure the port speed as follows: (config) # port 1/2/x1..x4 params admin enable (config) # port 1/2/x1..x4 params</p>

	<p>speed 25000</p> <p>Refer to <a href="#">GigaVUE-HC1-Plus Base Chassis</a> for more information.</p>
Management Ports	The MGMT and MGMT 3 ports support remote connections to the GigaVUE-OS using SSH. MGMT 2 port is reserved for future use.
Console Ports	Initial configuration is performed in the CLI over the serial RJ-45 Console port. Serial Console port accepts terminal connections for configuration of GigaVUE-HC1-Plus settings, including time, network, and SNMP settings.
Pseudo-Slots	<p>GigaVUE-HC1-Plus supports pseudo-slots . The mapping of pseudo-slots is as follows:</p> <p>Pseudo-slot 1 – 1/1/c1..c4,1/2/x1..x8,1/2/c1..c4</p> <p>Pseudo-slot 2 – 1/1/x1..x8,1/3/x1..x8,1/3/c1..c4</p> <p>To view the CLI output above, use the command <b>show pseudo-slot portmap box-id</b></p>
Reset /Push Button	Use the reset/ push button to reset the device.

### Rear Components on the GigaVUE-HC1-Plus Chassis

Power Supply Modules	<p>The GigaVUE-HC1-Plus includes two separate power supply modules installed at the node's rear. Each power supply module can independently operate the GigaVUE-HC1-Plus for 1+1 system redundancy and are hot- swappable. Separate AC and DC power units are available.</p> <p>Refer to <a href="#">Power Requirements</a> for information on the power characteristics of the GigaVUE-HC1-Plus.</p> <p>Refer to <a href="#">Module Removal and Replacement Procedure (Hot Removal)</a> for more information on hot-swapping the module.</p>
SMT-HC1A-R GigaSMART Module	The fixed rear GigaSMART line card comes with 2.0 GHz capability. Module' s ports are compatible with all features supported by GigaVUE® HC series platforms.
Fan Trays	The fan trays installed at the rear of the node provide system cooling. Fan trays are also hot-swappable. Refer to <a href="#">Module Removal and Replacement Procedure (Hot Removal)</a> for more information on hot-swapping the module.

## Hardware Root of Trust (HROt)

The Hardware Root of Trust is designed to establish a secure foundation for trust within the system using a secure microcontroller that is highly resistant to attacks. It offers the most robust form of IP security, with multiple levels of critical verification during power-on.

To configure the HROt solution, refer to the GigaVUE-OS CLI Reference Guide.

## Dual BIOS Image

The GigaVUE-HC1-Plus has a dual Basic Input/Output System (BIOS). The BIOS image is packaged with the software image, starting in software version 6.0. The BIOS contents are stored in flash memory, allowing the BIOS to be upgraded. There are two flash components, a primary and a secondary.

The following CLI command displays the two flash components and indicates the BIOS image from which the system booted using asterisks:

```
(config) show version
...
1st flash version: Yantra.41.011p.0 **
2nd flash version: Yantra.41.011p.0
SW BIOS version:  Yantra.41.011p.0
...
```

If there is a component failure in the primary flash, the GigaVUE-HC1-Plus boots from a backup golden BIOS image in the secondary flash. An SNMP trap can be configured to be sent when the system has booted from the secondary flash. The trap may indicate that the primary flash component needs to be serviced. The trap is as follows:

### **2ndflashboot: Secondary flash boot notification**

If a BIOS upgrade is required for future releases, you can manually upgrade the BIOS from the CLI using the coreboot install command.

## Chassis Cooling

The fans on the GigaVUE-HC1-Plus run at 100% of their maximum speed on power-up, then drop to approximately 65% during normal operations. The fans are deployed in 2+1 redundancy mode, meaning that a single fan can fail, and the third fan can immediately help the chassis maintain the appropriate cooling temperature at 40°C ambient. They are also hot-swappable. Refer to [Module Removal and Replacement Procedure \(Hot Removal\)](#) for more information on hot-swapping the module.

The temperatures of five components: intake, exhaust, CPU, switch CPU, and GigaSMART CPU temperatures are monitored. When a component crosses a pre-defined threshold, the fan speed is adjusted dynamically in increments of approximately 10%.

An SNMP trap is sent when a component reaches the threshold for warning, alert, or critical temperature conditions. Refer to [Table 2: Component Temperature Thresholds and Actions](#) for the temperatures at which the warning, alert, and critical traps are sent.

Table 2: Component Temperature Thresholds and Actions

Exhaust Temperature	CPU Temperature	Switch CPU Temperature	GigaSMART CPU Temperature
85°C Warning trap sent	90°C Warning trap sent	105°C Warning trap sent	90°C Warning trap sent
90°C Alert trap sent	95°C Alert trap sent	115°C Alert trap sent	95°C Alert trap sent
95°C Critical trap sent	100°C Critical trap sent	140°C Critical trap sent	100°C Critical trap sent

The output of the CLI command displays the current intake, exhaust, CPU, switch CPU temperatures, and the GigaSMART CPU temperature. The output of the following CLI command displays the fan speed in RPM (the normal operational speed is approximately 12000 RPM; the maximum speed is approximately 19000 RPM):

```
HC1P-HROT-Remote (config) # show environment
*** Box 1 (GVS-HC1P0/CHS-HW) ***
-----
Power Module 1 (PWR-TAC21):
Product Code           : 132-00F1
Serial Num             : 1F10-06A1
HW Rev                 : A0
Status                 : on
Capacity               : N/A
12v voltage            : 11.941 V
-----
Power Module 2 (N/A):
Product Code           : N/A
Serial Num             : N/A
HW Rev                 : N/A
Status                 : absent
Capacity               : N/A
12v voltage            : 0.0 V
-----
Fan tray 1 (FAN-HC1P):
1st fan                : 14195 RPM
2nd fan                : 13063 RPM
3rd fan                : 14144 RPM
4th fan                : 13063 RPM
-----
Fan tray 2 (FAN-HC1P):
1st fan                : 13845 RPM
2nd fan                : 12725 RPM
3rd fan                : 13845 RPM
4th fan                : 12684 RPM
-----
Fan tray 3 (FAN-HC1P):
1st fan                : 13797 RPM
2nd fan                : 12684 RPM
3rd fan                : 13845 RPM
4th fan                : 12684 RPM
-----
Card cc1 (GVS-HC1P0/MB-HW):
```

```

Intake temperature           : 29 C
Exhaust temperature         : 35 C
Cpu temperature             : 35 C
Switch temperature          : 36 C
vddcore_td3 voltage         : 0.817V
0.8v voltage                : 0.798V
3.3v voltage                : 3.281V
5.0v voltage                : 5.000V
3.3v_fpga voltage          : 3.320V
2.5v voltage                : 2.520V
1.8v voltage                : 1.790V
1.2v voltage                : 1.190V
1.0v voltage                : 0.970V
2.5v_fpga voltage          : 2.490V
core_fpga voltage           : 1.100V

```

-----  
Card 2 (PRT-HC1-Q04X08-HW):

```

Intake temperature           : 40 C
Exhaust temperature         : 32 C

```

-----  
Card 4 (SMT-HC1P-R):

```

Intake temperature           : 32 C
Exhaust temperature         : 37 C
oct0_vdd_3.3v voltage       : 3.323V
oct0_vdd_sys_ddr0 voltage   : 0.855V
oct0_vdd_sys_ddr1 voltage   : 0.856V
oct0_vdda_gser voltage      : 1.074V
oct0_vdd_ddr0 voltage       : 1.199V
oct0_vdd_ddr1 voltage       : 1.199V
oct0_vdd_core voltage       : 0.947V
oct0_vdd_sys voltage        : 0.849V
oct0_vdd_2.5v_vpp0 voltage  : 2.503V
oct0_vdd_2.5v_vpp1 voltage  : 2.515V
oct0_vddhv_gser voltage     : 1.224V
hotswap_control voltage     : 11.918V
vcc_fan_3v3 voltage         : 3.318V

```

=====

```

HC1P-HROT-Remote (config) # show environment type fan

```

```

*** Box 1 (GVS-HC1P0/CHS-HW) ***

```

-----  
Fan tray 1 (FAN-HC1P):

```

1st fan                      : 14246 RPM
2nd fan                      : 13020 RPM
3rd fan                      : 14195 RPM
4th fan                      : 12977 RPM

```

-----  
Fan tray 2 (FAN-HC1P):

```

1st fan                      : 13797 RPM
2nd fan                      : 12643 RPM
3rd fan                      : 13845 RPM
4th fan                      : 12643 RPM

```

-----  
Fan tray 3 (FAN-HC1P):

```

1st fan                      : 13797 RPM
2nd fan                      : 12643 RPM
3rd fan                      : 13845 RPM
4th fan                      : 12684 RPM

```

```
=====
HC1P-HROT-Remote (config) #
```

The `show chassis` command gives the following:

```
HC1P (config) # sh chassis

Chassis:
  Box ID       : 5*
  Hostname     : HC1P
  Config       : yes
  Mode         : default
  Oper Status  : up
  HW Type      : GVS-HC1P0/CHS
  Vendor       : Gigamon
  Product Code : 132-00GU
  Serial Num   : T0069
  HW Rev       : 2.0
  SW Rev       : 6.0.00
  GDP          : disable
  Tag Mode     : double
```

## Air Flow Direction

The airflow direction is from the front of the GigaVUE® HC series chassis to the rear. The rear-mounted fans pull air from the front to the back of the chassis. For environments with hot/cold aisles, install the chassis so the intake air at the front of the chassis is cold.

## AC- and DC-Powered GigaVUE-HC1-Plus

Gigamon provides both AC- and DC-powered versions of the GigaVUE-HC1-Plus. Refer to [Connecting Power to the GigaVUE-HC1-Plus](#) for information on connecting AC and DC power supplies.

## Breakout Panels

Breakout panels let you connect ports on a GigaVUE® HC series node to a tool or, network port, or TAP for port breakout or aggregation.

The following breakout panels are available:

- PNL-M341/PNL-M341T
- PNL-M343/PNL-M343T

Refer to the *G-TAP M Series Hardware Guide* for details.

# GigaVUE-HC1-Plus Base Chassis

The base chassis HC1P-C04X08 is the heart of the GigaVUE-HC1-Plus, providing processing and switching fabric resources and user access to the CLI via the Mgmt/console ports.

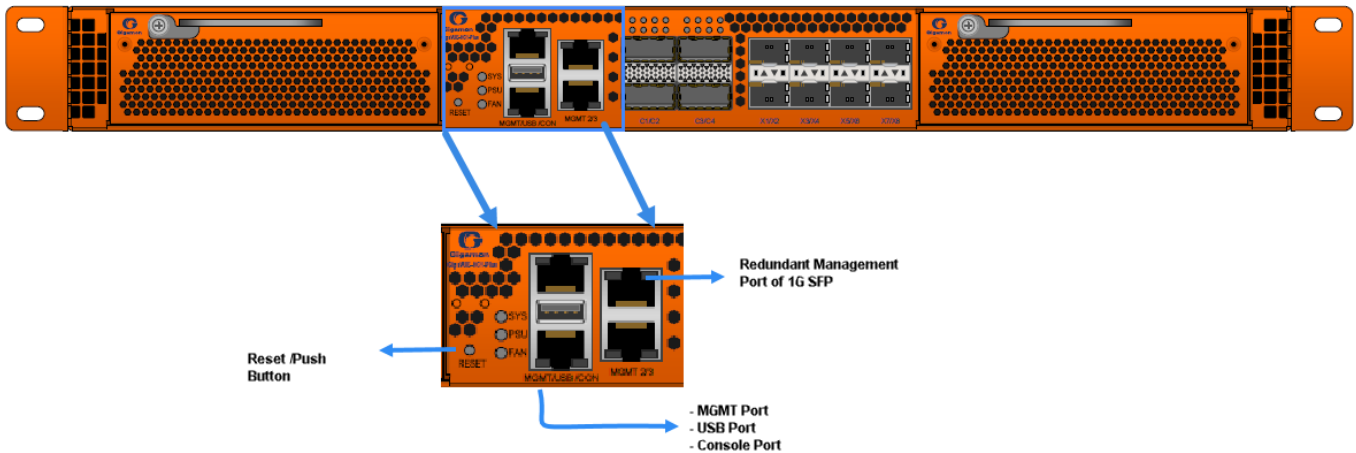

## Port Numbering

The base chassis uses standard conventions for identifying network/ tool ports, both on the modules themselves as well as in the CLI:

<b>100Gb/40Gb Ports</b>	<ul style="list-style-type: none"> <li>▪ Numbered with a leading <b>C</b>. For example, the base chassis includes 40Gb/100Gb ports <b>C1</b> to <b>C4</b>.</li> </ul>
<b>25Gb/10Gb/1Gb Ports</b>	<ul style="list-style-type: none"> <li>▪ Numbered with a leading <b>X</b>. For example, the base chassis includes 1Gb/10Gb/25Gb ports <b>X1</b> to <b>X8</b>.</li> </ul>

**NOTE:** In one quad( a group of four ports), there cannot be a mix of 10Gb, 25Gb, or 1Gb ports.

**NOTE:** When referring to ports in the CLI, the format is **box ID/slot ID/port ID**. For example, **1/1/x6** refers to box 1, slot 1, port X6.

- **GigaVUE-HC1-Plus:** The base chassis is numbered 1. Slots (bays) are numbered 2-3 from left to right.

**NOTE:** The port labels on the base chassis faceplate use upper-case C, and X characters to identify ports. However, the CLI uses lowercase notation to refer to ports (for example, c1 and x1).

## Module Status LEDs

The module status LEDs are as follows:

- RDY is the Ready LED. It has the following states:
  - RED indicates the system is booting up
  - GREEN indicates the system is ready
- POWER is the Power LED. It has the following state:
  - GREEN indicates the module is receiving power

## System LED

The system LED on the front of the chassis is as follows:

- Slow blink RED indicates that HRoT MCU is in the pre-boot phase.
- Fast blink RED indicates that the HRoT MCU has loaded and started to execute the primary/golden firmware image.
- Slow blink GREEN indicates that the HRoT MCU has authenticated BIOS image and allowed the CPU to start booting up.
- Fast blink GREEN indicates that the BIOS boot-up is complete. If the system has booted BIOS from the golden path, the SYS LED will continue showing “Fast blink GREEN” even after the GigaVUE-OS is up.
- Solid GREEN indicates that the system has booted completely via the primary path, the GigaVUE\_OS is UP and the system operates normally without alarms.
- Solid RED indicates Boot-up failure after the system is online and operational. It also indicates a critical alarm (such as over-temperature).

## PSU Led

The individual power LED status on the chassis is as follows:

- OFF indicates that the PSU is receiving no power.
- Blinking GREEN indicates that the system has two PSUs, one operating normally without any warning/alarm and the other having no input voltage.
- Solid GREEN indicates normal operation.



## Management Port LED

The Management Port LED on the front of the chassis is as follows:

- The LINK LED ( Left side) status is as below:
  - Off indicates that there is no link established on the port.
  - Solid GREEN indicates that a valid link at 1000Mbps is established on the port.
- The ACT LED ( right side) status is as below:
  - Off indicates that there is no link is established on the port.
  - Blinking GREEN indicates that the port is active and transmitting or receiving packets.

## Fan Status LED

The Fan status LEDs on the front of the chassis are as follows:

- OFF indicates that there is no power.
- Blinking RED indicates that one fan tray is missing or failed (the system can operate with one failed or missing fan tray but needs servicing).
- Solid RED indicates that more than one fan tray is missing or has failed
- Solid GREEN indicates the normal operation is happening with all fans in healthy state.

The Fan status LEDs on the front and the rear of the chassis are as follows:

- Solid GREEN indicates that the fan is operating normally.
- Solid AMBER indicates that the fan has failed.

## Base Chassis Port Status LEDs

The 10Gb port status LED has the following states:

- Off indicates the port is administratively enabled, but the link is operationally down.
- GREEN indicates the link is operationally up.

# GigaVUE-HCI-Plus Modules

The GigaVUE-HCI-Plus has two bays for replaceable modules. The following modules are available for the GigaVUE-HCI-Plus:

Module	Description	Section
<b>BPS-HC1-D25A60 and BPS-HC1-D35C60</b>	Bypass Modules, GigaVUE-HC1-Plus, with six SX/SR (50/125µm multi-mode) and six LX/LR single-mode inline network port pairs	<i>Bypass Modules (BPS-HC1-D25A60 SX/SR, BPS-HC1-D35C60 LX/LR)</i>
<b>SMT-HC1A-R</b>	The embedded GigaSMART engine with 2.0 GHz capability.	<i>SMT-HC1A-R</i>
<b>PRT-HC1-Q04X08 Module</b>	The PRT-HC1-Q04X08 line card module increases the port density and allows GigaVUE-HC1-Plus to connect with GigaVUE TA Series and GigaVUE HC Series nodes with higher-speed (25Gb/100Gb) links.	<i>PRT-HC1-Q04X08 Module</i>
<b>Generation 3 GigaSMART Card (SMT-HC1-S)</b>	Generation 3 GigaSMART module, (SMT-HC1-S) gives 80Gb throughput.	<i>SMT-HC1-S (Gen 3 GigaSMART Card)</i>
<b>PRT-HC1-X12</b>	PRT-HC1-X12 provides twelve 10Gb/1Gb SFP+/SFP network, tool, hybrid, inline network, and inline tool ports. Moreover, 10Gb ports can be used as stack-link ports.	<i>PRT-HC1-X12 Module</i>
<b>BPS-HC1-D25A24</b>	Bypass Combo Module, GigaVUE-HC1-Plus, with two SX/SR (50/125µm multi-mode) inline network port pairs and four SFP and SFP+ copper port cages	<i>BPS-HC1-D25A24 Bypass Combo Module</i>
<b>TAP-HC1-G10040</b>	Copper TAP with 4 x 1Gb 1000Mb ports for either four TAPs or bypass copper (BPC) port pairs	<i>TAP-HC1-G10040 Module</i>

Modules are hot-swappable and can be installed in any available front bays in a GigaVUE-HC1-Plus node. **However, refer to [Module Removal and Replacement Procedure \(Hot Removal\)](#) for instructions – you must follow a specific procedure when removing modules to preserve node stability.**

**NOTE:** The protected 1Gb link will remain down after performing a shutdown and no shutdown on the BPS-HC1-D25A24 module, as well as during module Online Insertion and Removal (OIR) on the GigaVUE-HC1-Plus chassis. Disabling and re-enabling the port will help to restore the link.

## Bypass Modules (BPS-HC1-D25A60 SX/SR, BPS-HC1-D35C60 LX/LR)

The BPS-HC1-D25A60 is multi-mode SR, and BPS-HC1-D35C60 is single-mode LR 1Gb/10Gb bypass modules. Bypass Modules offer six inline network port pairs each.

**Figure 3** BPS-HC1-D25A60

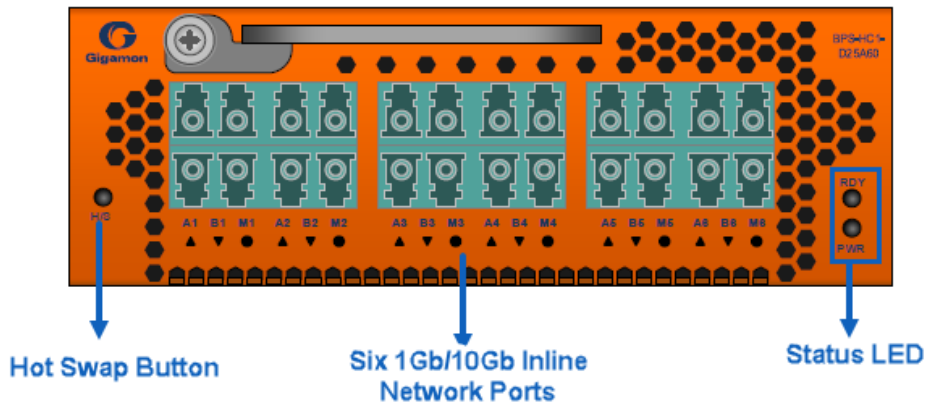
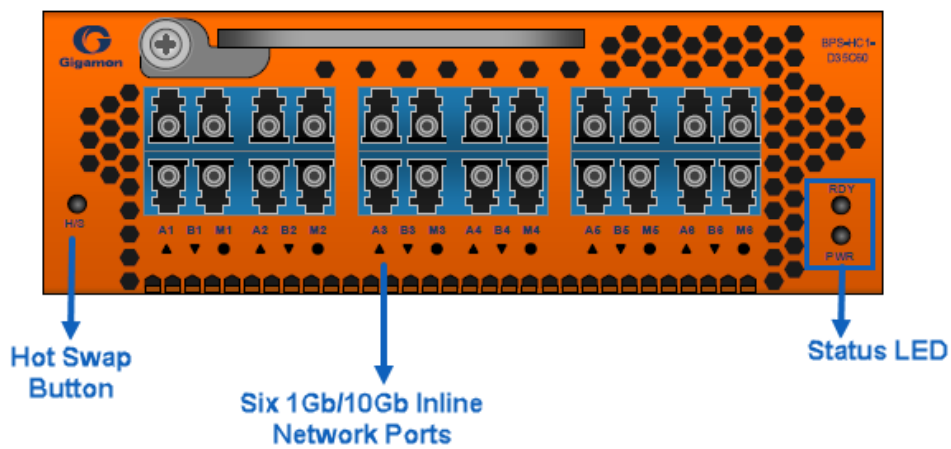

Figure 4 BPS-HCI-D35C60



Before installing a Bypass Module, the GigaVUE-HCI-Plus must run on the software version 6.00 or higher. For internal transceiver and loss summary specifications, refer to Bypass Module Specifications.

The GigaVUE-HCI-Plus offers physical and logical Inline Bypass. Physical bypass provides automatic failover protection in the case of a power failure. The bypass modules provide the physical bypass function. As it applies to a single pair of inline network ports, the physical bypass function is as follows:

- When the module is not powered (either the entire node is powered down or the module is removed from the node), the inline network port pair is in the physical bypass mode. That means traffic is exchanged directly between network Port A and Port B of the inline network pair.
- When the module is powered, the mode (inline or bypass) of the inline network port pair is controlled through software. In the physical bypass mode, the inline network port pair behaves exactly as if the module was not powered. In inline mode, the inline network port pair behaves like any other inline network port pair configured to work with an inline tool.

Modules are hot-swappable. Refer to [Hot Swapping Modules](#) for instructions.

### Features of the 10Gb Bypass Modules:

- Six inline network port pairs that pass traffic bi-directionally.
- Port pairs that offer optical protection switches for physical bypass.
- Option to select between bypass or inline modes.
- The hot-swap button is not supported, but the command "**card slot <slot id> down**" can be used to hot-swap the module from the chassis.

## Module Status LEDs

The following module status LEDs are located on the front of the bypass modules:

- RDY is the Ready LED. It has the following states:
  - RED indicates system booting or module down
  - GREEN indicates normal condition
- POWER is the Power LED. It has the following state:
  - GREEN indicates the module is receiving power

## Inline Network Ports

Connect inline networks to the inline network ports. The inline network ports have built-in protection for power down.

The inline network status LEDs have the following labels:

- A—Inline network LED A
- B—Inline network LED B
- M—Mode LED (on is inline and off is bypass)

## SMT-HC1A-R

SMT-HC1A-R is the embedded GigaSMART engine of GigaVUE-HC1-Plus with 2.0 GHz capability. This GigaSMART engine has one GigaSMART chip. The embedded GigaSMART engine is fixed and cannot be installed/removed.

## PRT-HC1-Q04X08 Module

The PRT-HC1-Q04X08 line card consists of four (4) 40Gb/100Gb QSFP+ ports and eight (8) 1Gb/10Gb/25Gb /SFP/SFP+/SFP28 ports. This module increases the port density and allows GigaVUE-HC1-Plus to connect with GigaVUE TA Series and GigaVUE HC Series nodes with higher-speed (100Gb) links. It provides 600Gb connectivity with line rate on-board switching across the 1Gb/10Gb/25Gb/40Gb/100Gb ports.

The PRT-HC1-Q04X08 is a legacy GigaVUE-HC1-Plus line card, where the ports Q1..Q4, when inserted in GigaVUE-HC1-Plus will support 100Gb speed with the nomenclature C1..C4.

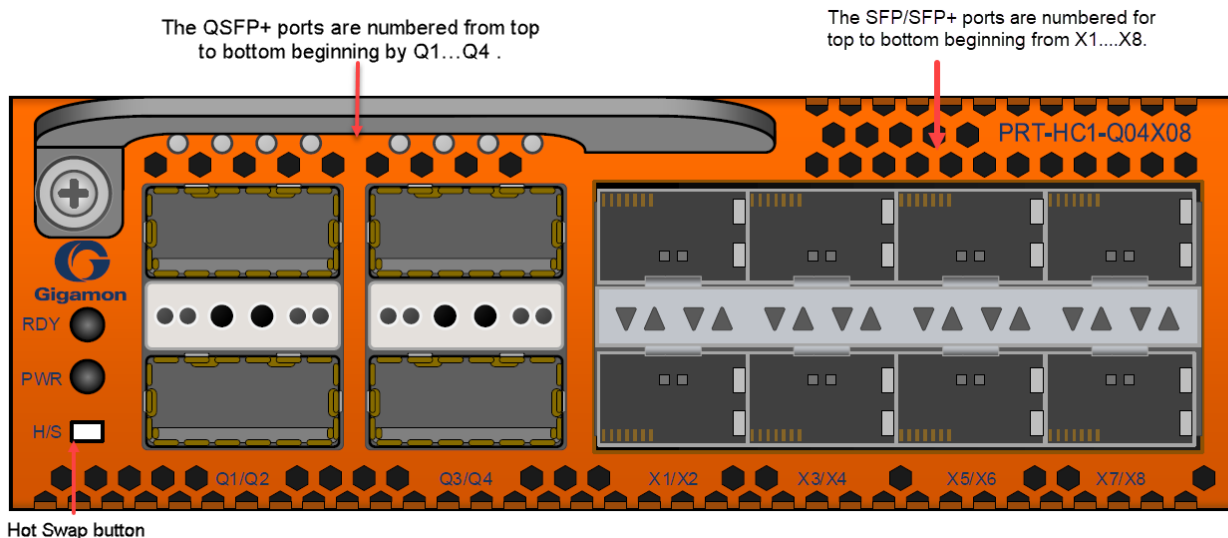

## Features

1. All ports, including breakout ports of this module, can be used as network, tool, hybrid, circuit, inline network, and inline tool ports. Every group of four ports (quad) can be configured as 25Gb. In one quad, there cannot be a mix of 10Gb and 25Gb ports. By default, all eight ports are configured as 10Gb ports. To configure 25Gb, you must configure the port speed as follows: (config) # port 1/2/x1..x4 params admin enable (config) # port 1/2/x1..x4 params speed 25000.
2. The ports can be used for 10Gb/40Gb/100Gb, 4x10Gb and 4x25Gb stacking.

- The module supports 4x25Gb breakout on 100Gb ports and 4x10Gb breakout on the 40G ports using SR4 optics (PLR4/PSM4 optics are only supported for 100Gb).
- The breakout ports can be used in clustering and support IP interface configuration for netflow and tunneling. The ports in the line card can also be added as part of GigaStream.
- This module is hot-swappable by using the H/S button.

For details about the supported transceiver, cable type, fan-out, inline ports, and clusters, refer to the GigaVUE-OS Compatibility and Interoperability Matrix.

## Module LEDs

The LEDs on the modules indicate the current operational status. The operational states indicated by the color of Power (PWR) and Ready (RDY) LEDs are as described below.

LEDs	Color	Description
PWR - Power LED	Solid Green	Indicates the module is receiving power
RDY - Ready LED	Solid Green	Indicates normal condition
	Solid Red	Indicates system booting or module down

## Port Status LEDs

The 40Gb/100Gb Port LED Q1..Q4 and 1Gb/10Gb/25Gb SFP/SFP+/SFP28 LED states are as described below:

LED	Color	Description
LED Q1..Q4	OFF	The Port is administratively disabled, or the link is down.
	Solid Green	Link up
Port LED X1..X8	OFF	The Port is administratively disabled, or the link is down.
	Solid Green	Link up
Activity LED	N/A	Unused

## SMT-HC1-S (Gen 3 GigaSMART Card)

GigaVUE-HC1-Plus now supports an additional module called the Generation 3 GigaSMART card (SMT-HC1-S), which gives 80Gb throughput. There are no front-end ports in this module.

The hot-swap button is not supported. But the modules are hot-swappable. Refer to [Hot Swapping Modules](#) for instructions.

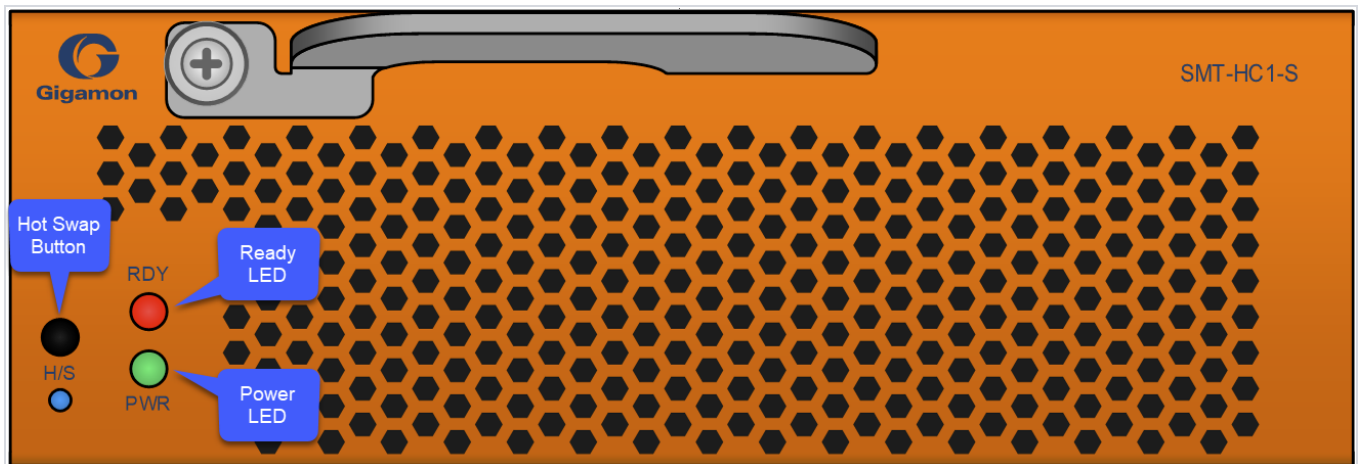

## Ports and LEDs

Generation 3 GigaSMART Card (SMT-HC1-S)	
<b>Maximum Modules Per Chassis</b>	The maximum SMT-HC1-S number of modules per chassis is two.
<b>Power LED (PWR)</b>	The LED indicates the operational status of the module as follows : <ul style="list-style-type: none"> <li>• OFF means the node is not powered up.</li> <li>• GREEN means the node is powered on.</li> </ul>
<b>Ready LED (RDY)</b>	The LED indicates the operational status of the module as follows : <ul style="list-style-type: none"> <li>• OFF means the node is inserted but not yet configured.</li> <li>• RED means the node has failed.</li> <li>• GREEN means the node is ready.</li> </ul>
<b>H/S LED</b>	The LED indicates the operational status of the module as follows : <ul style="list-style-type: none"> <li>• OFF means the node is in normal operation.</li> <li>• BLUE means the node is ready to be removed when the card is shut-down or not configured. LED turns on at insertion of module.</li> </ul>
<b>Hot Swap Button</b>	The hot-swap button is not supported, but the command " <b>card slot &lt;slot id&gt; down</b> " can be used to hot-swap the module from the chassis.

## PRT-HC1-X12 Module

The PRT-HC1-X12 module provides a total of 120Gb connectivity with line rate on-board switching across twelve 1Gb/10Gb SFP/SFP+ ports.

Before installing the PRT-HC1-X12 Module, the GigaVUE-HC1-Plus must be run software version 6.2 or higher. Refer to [Figure 5 PRT-HC1-X12 Module](#).



When two PRT-HC1-X12 modules are installed in the node, the GigaVUE-HC1-Plus provides twenty-four 1Gb/10Gb ports. All ports in the PRT-HC1-X12 module can be used as network, tool, hybrid, inline network, and inline tool ports. Moreover, the 10Gb ports can be used as stack-link ports.

The hot-swap button is not supported. But the modules are hot-swappable. Refer to [Hot Swapping Modules](#) for instructions.

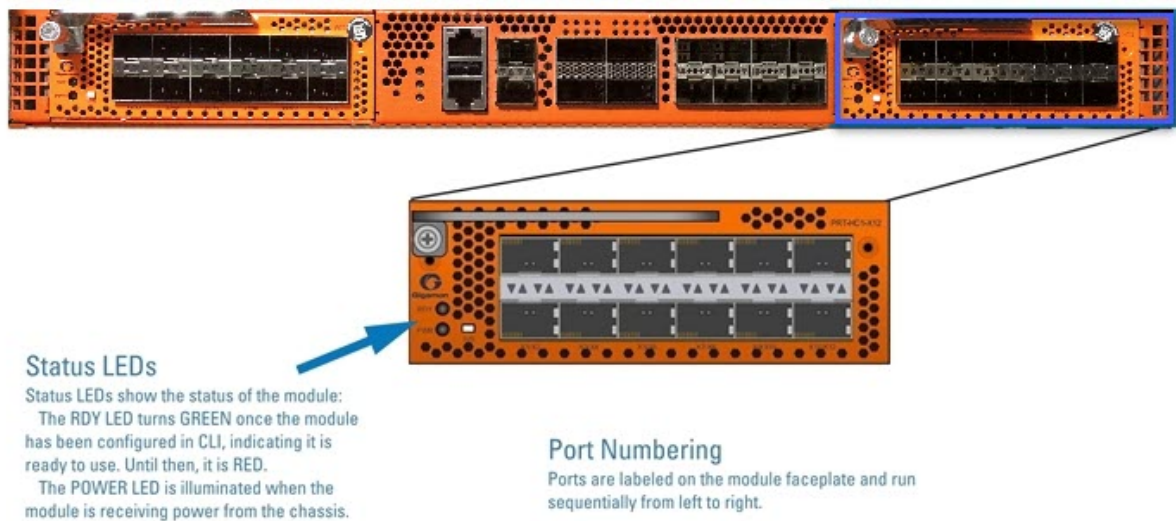

**Figure 5** PRT-HC1-X12 Module

## BPS-HC1-D25A24 Bypass Combo Module

There is one 10Gb bypass combo module as follows:

- Bypass Combo Module with two SX/SR (50/125µm multimode) inline network port pairs and four regular SFP+ port cages (BPS-HC1-D25A24) ([Figure 6 Bypass Combo Module BPS-HC1-D25A24](#))

Before installing the BPS-HC1-D25A24 Bypass Combo Module, the GigaVUE-HC1-Plus must be running software version 6.3 or higher.

For internal transceiver and loss summary specifications, refer to [Bypass Combo Module Specifications](#).

### Bypass Combo Modules

Security tools such as firewall and intrusion detection/protection systems are often connected inline on production networks, with traffic flowing from the network segment through the tool and then back onto the production network.

The GigaVUE-HC1-Plus offers physical and logical Inline Bypass. Physical bypass provides automatic failover protection in the case of a power failure. The bypass combo modules provide the physical bypass function. As it applies to a single pair of inline network ports, the physical bypass function is as follows:



- When the module is not powered (either the entire node is powered down or the module is removed from the node), the inline network port pair is in the physical bypass mode. That means traffic is exchanged directly between network Port A and Port B of the inline network pair.
- When the module is powered, the mode (inline or bypass) of the inline network port pair is controlled through software. In the physical bypass mode, the inline network port pair behaves exactly as if the module was not powered. In inline mode, the inline network port pair behaves like any other inline network port pair configured to work with an inline tool.

Modules are hot-swappable. Refer to [Hot Swapping Modules](#) for instructions.

## Features of the 10Gb Bypass Combo Module

The 10Gb bypass combo module has the following features:

- Two inline network port pairs that pass traffic bi-directionally.
- Port pairs that offer optical protection switches for physical bypass.
- Four regular SFP/SFP+ ports that can operate at 1Gb/10Gb. These ports can be configured as any port type.
- Option to select between bypass or inline modes.
- The hot-swap button is not supported, but the command "**card slot <slot id> down**" can be used to hot-swap the module from the chassis.

### BPS-HC1-D25A24

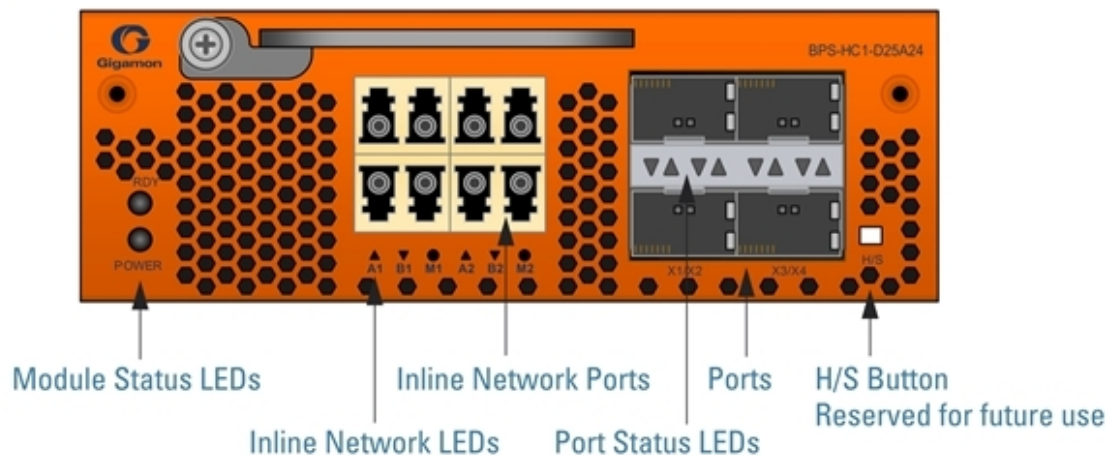

**Figure 6** Bypass Combo Module BPS-HC1-D25A24

## Module Status LEDs

The following module status LEDs are located on the front of the bypass combo module:

- RDY is the Ready LED. It has the following states:
  - RED indicates system booting or module down
  - GREEN indicates normal condition

- POWER is the Power LED. It has the following state:
  - GREEN indicates the module is receiving power

## Port Status LEDs

The SFP+ Port Status LEDs have the following states:

- Off indicates that the port is disabled or the link is down
- GREEN indicates that the link is established

## Ports

You can configure any two of the four 10Gb ports as an inline tool port pair and connect an inline tool to them.

For tool ports, you can also use ports on any module in the chassis, including ports on other bypass combo modules or ports on other GigaVUE-HC1-Plus modules.

Ports have the following labels: X1 to X4. In the CLI, these ports are referred to as: x1 to x4.

## Inline Network Ports

Connect inline networks to the inline network ports. The inline network ports have built-in protection for power down.

The inline network status LEDs have the following labels:

- A1—Inline network LED A (for network 1 through network 2)
- B1—Inline network LED B (for network 1 through network 2)
- M1—Mode LED (on is inline and off is bypass)
- A2—Inline network LED A (for network 1 through network 2)
- B2—Inline network LED B (for network 1 through network 2)
- M2—Mode LED (on is inline and off is bypass)

**NOTE:** In the CLI, the inline network ports are referred to as x5 to x8.

# TAP-HC1-G10040 Module

The TAP-HC1-G10040 module provides four 1Gb Copper TAP connections to be used as network ports. This module has 8 ports, enabling 4 TAPs. Each port pair is arranged with one port above the other, providing bidirectional traffic flow between two nodes. Traffic is copied through the use of a port pair unless the port pair is in the physical bypass state. The hot-swap button is not supported. But the modules are hot-swappable. Refer to [Hot Swapping Modules](#) for instructions.

Before installing the TAP-HC1-G10040 Module, the GigaVUE-HC1-Plus must be run software version 6.4 or higher. Refer to [Figure 7 TAP-HC1-G10040 Module](#).

For details about the connectivity specifications, refer to “GigaVUE-OS Compatibility and Interoperability Matrix”.

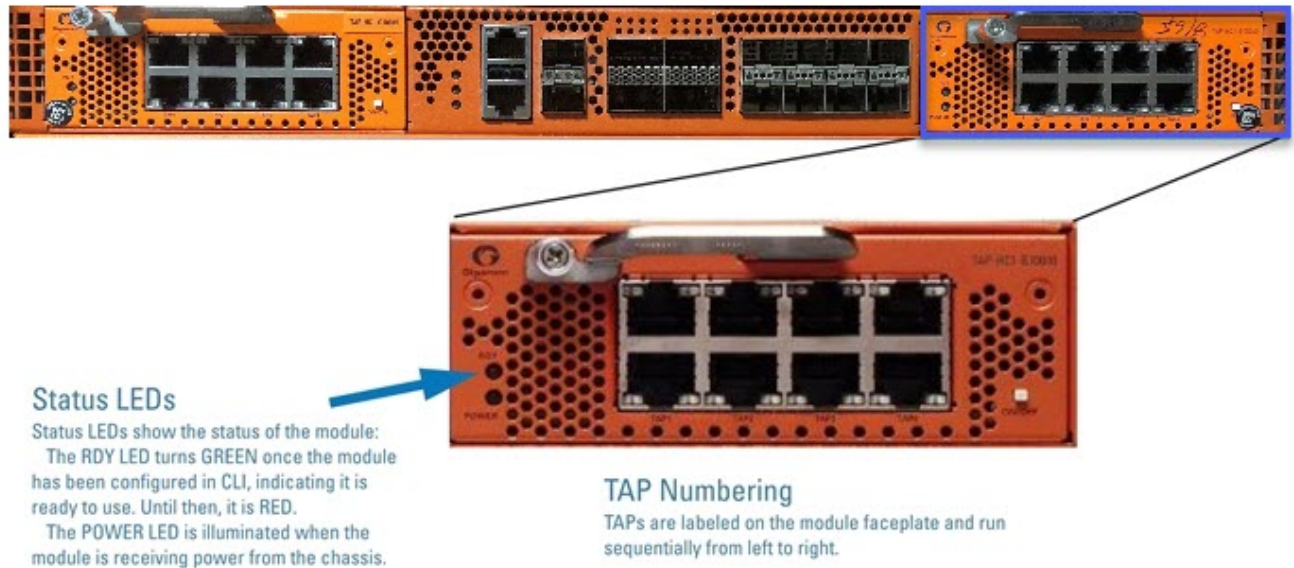

**Figure 7** TAP-HCI-G10040 Module

## Using the TAP-HCI-G10040 Module for Copper Bypass

The network ports on the TAP-HCI-G10040 module can be configured through software to be inline network ports. This allows the TAP-HCI-G10040 module to act as a copper bypass module, providing protected inline networks for copper ports.

To use the copper bypass functionality, the GigaVUE-HCI-Plus must be run GigaVUE-OS version 6.4 or higher. For configuration information, refer to the “Configuring Inline Bypass Solution on GigaVUE HC Series TAP Modules” chapter in the *GigaVUE-OS CLI Reference Guide*.

## Using TAP-HCI-G10040 Module for Gigamon Resiliency for Inline Protection

Gigamon Resiliency for Inline Protection (GRIP)<sup>™</sup> is an inline bypass solution that connects two GigaVUE-HCI-Plus nodes so that one node provides high availability to the other node when there is a loss of power. This redundant arrangement of two GigaVUE-HCI-Plus nodes maintains traffic monitoring by inline tools when one of the nodes is down.

GRIP™ makes use of the bypass protection switch relays for protected inline networks on GigaVUE-HC1-Plus nodes. The TAP-HC1-G10040 module can provide physical protection for protected pairs of copper inline network ports required by the GRIP solution. For solution and configuration information, refer to the chapter “Configuring Inline Bypass Solutions” in the *GigaVUE-OS CLI Reference Guide*.

## Upgrading PLDs

Use the **pld** CLI command to upgrade programmable logic devices (PLDs) on GigaVUE-HC1-Plus nodes. These devices include field programmable gate arrays (FPGAs). The following components have an FPGA:

- HC1P-C04X08 module ( main board)
- BPS-HC1-D25A60 module
- BPS-HC1-D35C60 module
- SMT-HC1A-R module

**NOTE:** The Legacy modules PRT-Q04X08, SMT-HC1-S, and PRT-HC1-X12, BPS-HC1-D25A24, and TAP-HC1-G10040 cards does not support PLD Upgrade.

FPGA images are bundled with the software image and upgraded with the software image upgrade. However, the **pld** command provides the ability to upgrade each FPGA individually.

After a PLD upgrade, the node requires a hard reboot.

Issue the **show pld** command to display the PLDs that need to be upgraded, then only upgrade those. Refer to the following example for GigaVUE-HC1-Plus:

```
HC1P-local (config) # sh pld
Box ID: 1
Slot      HW Type          Cur Rev  Need Upgrade
-----
cc1      HC1P-Main-Board-HW  7        no
1        HC1P-C04X08-HW     7        no
2        PRT-HC1-Q04X08     5        no
3        BPS-HC1-D35C60-HW  3        yes
4        SMT-HC1A-R         7        no
HC1P-local (config)
```

## GigaVUE-HC1-Plus Installation Roadmap

This chapter provides a flow chart of the major steps needed to get a GigaVUE-HC1-Plus node unpacked, rack-mounted, installed, and connected. It also describes what you should do once you have completed the initial setup of the node. Refer to the following sections for

details:

- [First Steps – Getting Unpacked, Racked, Installed and Connected](#)
- [Next Steps](#)

## First Steps – Getting Unpacked, Racked, Installed and Connected

You have received your GigaVUE-HCI-Plus node, and are now ready to get up and running. The major steps you need to perform to get the GigaVUE-HCI-Plus chassis out of the box, into a rack, installed with modules, plugged in, and running on your network are shown below:

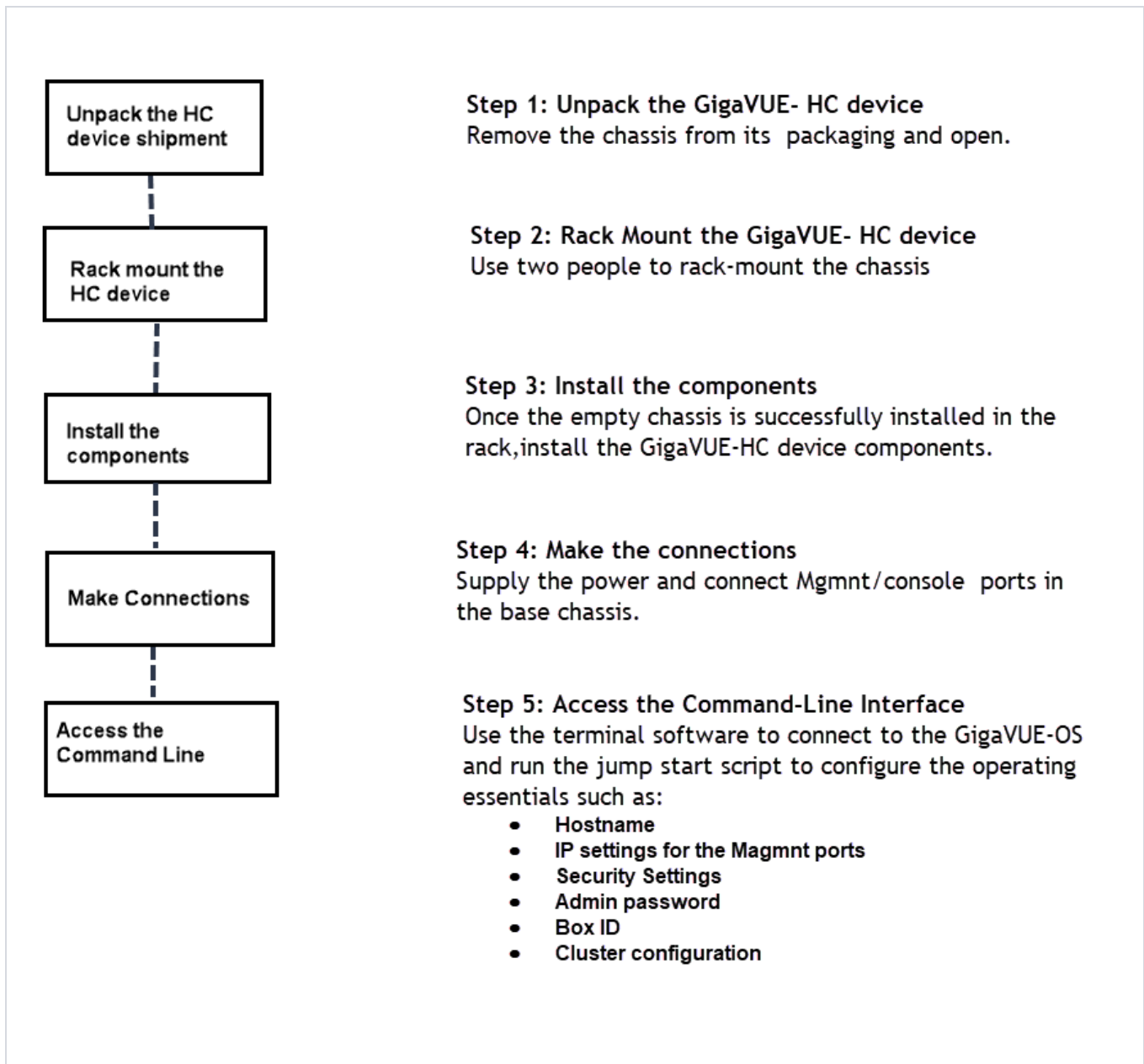

**Figure 8** Getting Started Roadmap

## Next Steps

Once you have performed the initial configuration of the GigaVUE-HCI-Plus node, installing, connecting, and configuring the node, you are ready to start mapping traffic between network and tool ports.

Refer to the *GigaVUE-OS CLI Reference Guide*, **GigaVUE Administration Guide**, and online help for information.

# Assembling the GigaVUE-HC1-Plus Node

This chapter explains how to unpack, rack-mount, and assemble the GigaVUE-HC1-Plus node using the components that came with your shipment.

Separate sections are provided for unpacking and rack-mounting the GigaVUE-HC1-Plus nodes, as well as installing and removing modules. Refer to the following sections for details:

- [Unpacking the GigaVUE-HC1-Plus Shipment](#)
- [Rack-Mounting the GigaVUE-HC1-Plus Chassis](#)
- [Installing and Removing Modules Procedure](#)
- [Module Removal and Replacement Procedure \(Hot Removal\)](#)

## Unpacking the GigaVUE-HC1-Plus Shipment

The GigaVUE-HC1-Plus node is shipped with either DC or AC power supply modules, fans, and filler panels installed. The chassis and parts kit are shipped in one box, and modules are shipped in separate boxes. Use the following procedure to unpack the node:

1. Inspect the shipping boxes. If any of the cartons were damaged, file a claim with the carrier who delivered them.
2. Open the box containing the GigaVUE-HC1-Plus chassis and remove the parts kit from the top of the shipment. The parts kit contains the power cords, console cable and adapter, and power supply module covers.
3. Open the additional boxes containing the ordered modules and set them aside for assembly (each module is shipped in separate boxes).
4. Leave all protective filler panels in place in the chassis. **DO NOT** install the modules yet. Gigamon recommends rack-mounting the GigaVUE-HC1-Plus chassis empty.

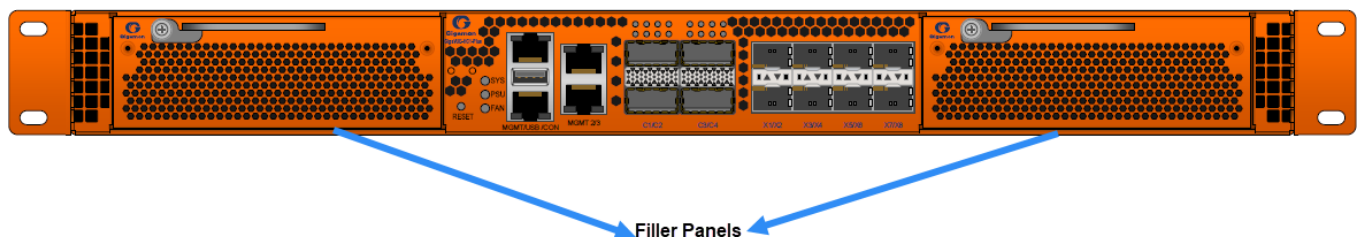



# Rack-Mounting the GigaVUE-HC1-Plus Chassis

This section describes how to rack-mount the GigaVUE-HC1-Plus chassis in a standard 1RU rack space using the hardware provided with the chassis. You can install the GigaVUE-HC1-Plus chassis in two-post or four-post racks with a depth of 17 inch wide x 23.5 deep x 1.75 long.

## Safety Precautions

Before you get started rack-mounting the GigaVUE-HC1-Plus chassis, make sure you have read the following safety precautions:

- There are a wide variety of racks available on the market. Make sure you consult the instructions provided by your rack vendor for detailed mounting instructions before installing the GigaVUE-HC1-Plus chassis.
- Make sure you install any stabilizers provided for the rack before installing the chassis. Unsecured racks can tip over and cause injury or death.
- Make sure you install devices in the rack from the bottom up, with the heaviest devices at the bottom.
- Make sure you provide adequate ventilation to the nodes installed in the rack.

## Rack-Mounting on GigaVUE-HC1-Plus

Use the following procedure to rack-mount the GigaVUE-HC1-Plus chassis:

1. **Decide whether you want to front-mount or center-mount the chassis in the rack.** Front-mounted nodes will sit flush with the front of the rack, while center-mounted nodes will extend in front of it.

**NOTE:** The GigaVUE-HC1-Plus chassis is not shipped with its standard rack ears attached. However, they are available in the accessory kit. Install the rack ears facing towards the node for a front-mounting position. You can reverse the direction of the rack-ears to center-mount the node.

Front Mount GigaVUE-HC1P

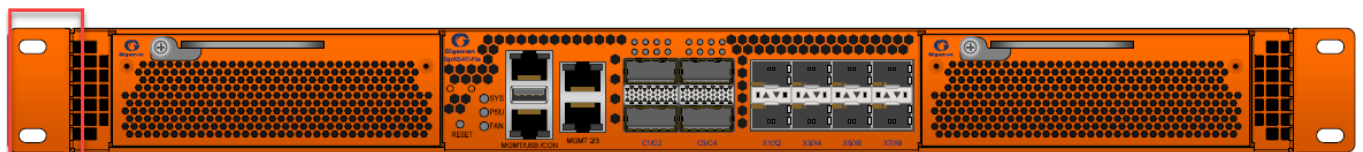

Rack ears face towards the front of the node for Front mounting



**Figure 9** Rack Ears for Front Mount (Reverse Rack Ears for Center Mount)

2. Make sure you have not installed any modules in the chassis yet. Gigamon recommends rack-mounting the GigaVUE-HC1-Plus chassis before installing modules to make it easier to handle the chassis during the installation.
3. Select a suitable location for the rack that will hold the GigaVUE-HC1-Plus chassis. Choose a location that is clean, dust-free, and well-ventilated. You will need access to grounded power sources. Avoid areas where heat, electrical wire, and electromagnetic fields are generated.

Plan for enough clearance in front of a rack to access the modules easily (approximately 25in [63.50cm]) and enough clearance in the back of the rack to allow sufficient airflow and installation of the rear components, such as power supply modules.

4. Locate an open 1RU rack space and lift the node into place. It takes two people to lift to place the GigaVUE-HC1-Plus in the rack. Insert a screw through the rack ear on each side into the rack to hold the node in place. Tighten the screws.
5. Carefully lift the chassis into the rack and place a screw on each side to hold the chassis.
6. Tighten the screws and add additional screws to secure the node. **Use two screws on each rack ear.**

## Four-Post Rack Mounting

Use rack ears and full-length brackets to mount the GigaVUE-HC1-Plus in a four-post rack. The rack ears attach at the front of the unit, and the brackets attach at the rear, as follows:

- Attach the rack ears so they face towards the front of the system for mounting in four-post racks.
- Attach the full-length brackets to the sides of the GigaVUE-HC1-Plus with enough free play to position them to fit your rack's dimensions. After the brackets are attached to the rack's rear posts, tighten the bracket connections to the sides of the GigaVUE-HC1-Plus.

Refer to [Figure 10 Extended Bracket Installation](#) for the four-post rack installation using the extended brackets.

Extended Bracket



**Figure 10** *Extended Bracket Installation*

## Installing and Removing Modules Procedure

The procedure for installing modules is to remove the filler panels, install the module, then fasten it with the ejector lever and tighten the thumb screw on top of the lever. The following procedure has the details.

### Hot Swapping Modules

Modules are hot-swappable – they can be installed or removed from the chassis with the power on. **To remove a module safely with the power on, you must follow the procedure in [Module Removal and Replacement Procedure \(Hot Removal\)](#).**

**Install proper software versions prior to inserting any new modules.**

Gigamon often makes new modules available for GigaVUE-HCI-Plus nodes. New modules are usually introduced starting with a new software release. Make sure you install the supporting software release before installing the new module.

If you do install a new module before its supporting release, the module will appear in the **show cards** output with an **Operational Status** of **unsupported**.

In some cases, if you subsequently upgrade the node to the release that supports the new module, it can appear persistently in the **show cards** output with an **Operational Status** of **inserted**. To make the module operational, you must unconfigure it with the **no card slot x** command, followed by configuring the module with **card slot x**.

### Module Installation Procedure

Use the following procedure to install GigaVUE-HCI-Plus modules:

1. Make sure you are wearing an ESD-preventive wrist or ankle strap.
2. Locate the modules and remove them from their packaging.

3. Remove the protective filler panels from the target bays for all modules to be installed. Keep the filler panels so they can be easily reused if the module is ever removed. You can install modules in either of the two available front bays on the GigaVUE-HCI-Plus.

**NOTE:** To prevent any improper air flow and overheating the node, **do not leave any bays uncovered.**

4. Pull out the lever on the top of the module. Carefully slide the module into the bay. Push the lever back in and tighten using the thumb screw on the lever.

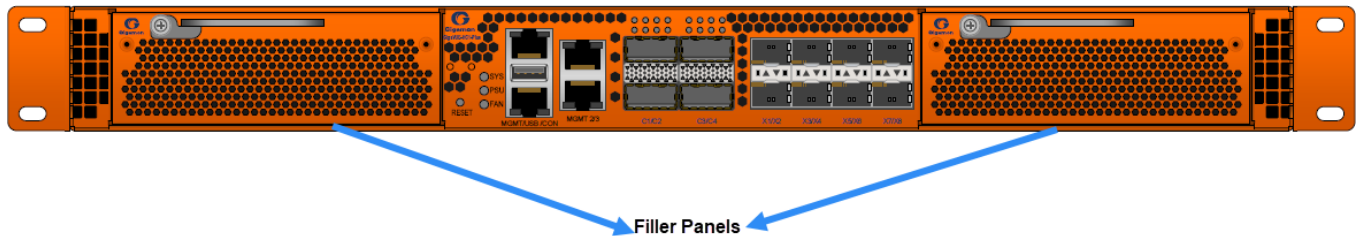

**Figure 11** *Installing Modules*

5. Install any additional modules by repeating the previous two steps.

**NOTE:** The first time you install a module in the node, you need to configure the node to recognize it with the **card** command and save your changes with **write memory**. Refer to [Configuring Basic GigaVUE® HC series Settings](#) for details.

**This completes the installation of the modules on the GigaVUE-HCI-Plus.**

## Module Removal and Replacement Procedure (Hot Removal)

Use the following procedure to remove a module from the GigaVUE-HCI-Plus node with the power on.

**IMPORTANT:** Hot removal of modules without following the listed steps can cause system instability and require a reboot.

Before starting, make sure you are wearing an ESD-preventive wrist or ankle strap.

### Replacing a Module with the Same Type of Module

1. Shut down the module to prepare for removal with the following CLI command:

```
(config) # card slot <slot id> down
```

2. Slide the module out of the chassis and store it in a static-safe location.

3. Insert the new module of the same type.

## Replacing a Module with a Different Type of Module

1. Remove all packet distribution configurations related to the module using the following CLI command:

```
(config) # no card slot <slot ID>
```

2. Slide the module out of the chassis and store it in a static-safe location.
3. Insert the new module of a different type.
4. Issue the following CLI command to make the card available for configuration:

```
(config) # card slot <slot ID>
```

## Fan Replacement Procedure

The replacement procedure would take less than 15 seconds. The fans provided are not hot-swappable. To remove a fan, do the following:

1. Power down the GigaVUE-HCT device.
2. Press the black tab toward the center of the fan module handle to release the latch and then pull.

To insert a fan module, proceed as follows:

1. Power down the GigaVUE-HCT device.
2. Insert the fan module into the empty slot and slide it until it is flush with the rear of the chassis, and it will not slide in any further.

## Next Steps

Refer to [Configuring Basic GigaVUE® HC series Settings](#) for information on connecting with the GigaVUE-OS to make your initial configuration settings.

# Basic GigaVUE® HC series Connections and Configuration

This chapter describes how to establish your first configuration session with the GigaVUE-HCI-Plus and set the basic initial configuration options necessary to get the node up and running.

Refer to the following sections for details:

- Grounding the GigaVUE-HC1-Plus Chassis
- Connecting Power to the GigaVUE-HC1-Plus
  - Connecting -48V DC Power Supply Modules
- Connecting Serial Console and Mgmt Ports
- Configuring Basic GigaVUE® HC series Settings
  - Access the Command-Line Interface over the Console Port
  - Run the Jump-Start Script
  - Configure Modules and Enable Ports
- Command-Line Basics
  - Command-Line Modes
  - Entering Commands in the CLI
  - Command-Line Syntax – Entering Commands
- The Basic Commands
- Completing the Initial GigaVUE® HC series Setup

## Grounding the GigaVUE-HC1-Plus Chassis

The GigaVUE-HC1P Chassis has the following warning as shown below.



The GigaVUE-HC1P chassis is drilled for ground screws near the left corner at the rear of the chassis.

Connect grounding wire with spade lugs to the ground screws on the chassis and earth ground using the following procedure.

1. Locate the grounding holes near the left corner at the rear of the chassis ([Figure 12 Holes for Ground Screws](#) shows the location on a GigaVUE-HC1-Plus node).



**Figure 12** Holes for Ground Screws

2. Install ground screws meeting the following specifications:

**#8 Panhead, Phillips-drive, Exterior SEM screw. Thread size = 32Length = 1/2in (1.27cm)**

3. Connect grounding wire with spade lugs both to the ground screws and to the earth ground. The specifications for the ground wire and lugs are as follows:

**Standard Wire 14 (AWG); Stud Size #6 (0.138in/0.351cm); Spade Width 0.32in/0.813cm**

4. Tighten the screws to secure both the chassis ground screws and the earth ground screws.

## Connecting Power to the GigaVUE-HC1-Plus

The GigaVUE-HC1-Plus supports AC and DC power in a 1+1 redundant configuration. In all cases, only a single power supply module is required to operate the node. However, connecting both modules in a 1+1 configuration provides redundant power.

**NOTE:** It is recommended not to insert different product codes PSU in the same chassis. Doing so will give an SNMP mismatch trap. For example, PSU PWR-TAC21 and PWR-HC1P1, PWR-TAC22 and PWR-HC1P2 must not co-exist in PSU slots; PSU AC/DC and PSU DC/DC must not co-exist in PSU slots.

The procedure for connecting power to the GigaVUE-HC1-Plus is similar to the other GigaVUE® HC series nodes:

GigaVUE® HC series Chassis Type	Number of Power Supply Modules
GigaVUE-HC1-Plus	2

1. Plug an approved C13 power cable into each power supply module at the rear of the GigaVUE-HC1-Plus chassis.

**Note:** For information about connecting the optional DC power supply modules, refer to Connecting DC Power Supply Module.

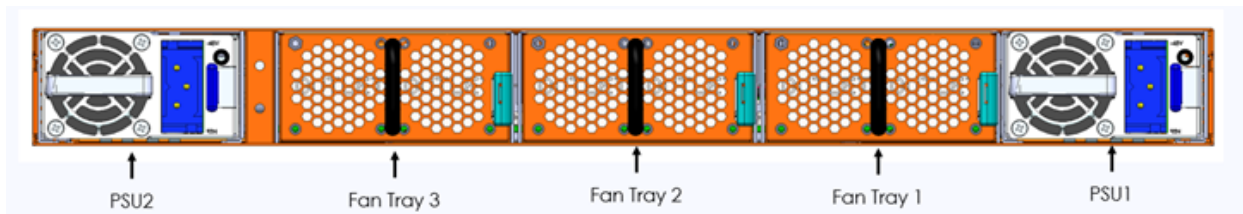

**Figure 13** Connecting AC Power (GigaVUE-HC1-Plus)

2. Plug the other end of the power cables into a power source that can supply adequate power. For optimal power protection, plug the power supply modules into separate circuits. When connecting to the external AC power source, ensure that a Surge Protective Device (SPD) is installed at the AC power inlet. For information about GigaVUE-HCI-Plus power requirements, refer to [AC- and DC-Powered GigaVUE-HCI-Plus](#).

**NOTE:** To avoid disk corruption, please ensure the "reload halt" command is executed before an ungraceful power shutdown or power supply module removal.

3. Power is turned ON when the unit is plugged in and turned off when the unit is unplugged. To remove a power supply module, refer to the [Removing a Power Supply Module](#).
4. Once the power supply is turned OFF, wait for 1 minute (60 seconds) before turning the power supply ON for GigaVUE-HCI-Plus.

## Removing a Power Supply Module

When removing a power supply module, refer to the following label on the chassis:

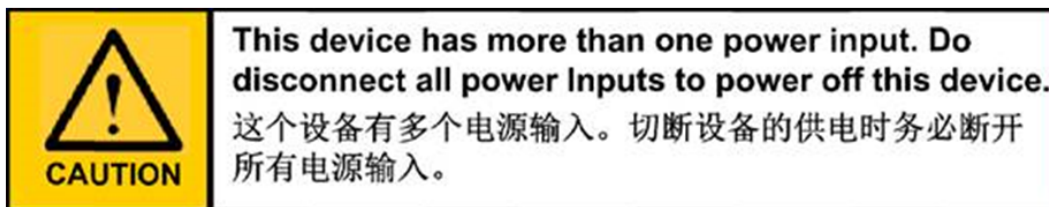

**Figure 14** Power Caution Label

To remove a power supply module:

1. Power down the module by disconnecting the power inputs.
2. Wait about 90 seconds for the node to stabilize.
3. Remove the power supply module.

**NOTE:** Do not remove a power supply module while inputs are still connected.

## Connecting -48V DC Power Supply Modules

The GigaVUE-HCI-Plus is available with DC power supply modules. This section provides instructions for connecting a -48V DC power source to the DC power supply modules.

**To connect a -48V DC input to the DC power supply module:**

1. Plug the DC power cable adapter into the DC power supply.



**NOTE:** Terminal block supports 10AWG.

2. If PSM grounding is required, connect earth ground to the SAFETY GROUND (green/yellow) terminal using a straight blade screwdriver.



**NOTE:** An adapter or pigtail, both of which are in the shipping package, is required for the PWR-TAC22 DC/DC PSU.

**NOTE:** Pigtails or adapters are not required for the PWR-HC1P2 DC/DC PSU.

**Figure 15** Connecting DC Power Supply Module (2 different types of power modules)

3. Connect the positive and negative power wires using a straight blade screwdriver to the appropriate terminals.
  - o Connect the positive source wire to the + RETURN (black) terminal using a straight-blade screwdriver.
  - o Connect the -48V source wire to the -48V (blue) terminal using a straight blade screwdriver.

**IMPORTANT:** The leads to the DC power supply modules on the GigaVUE-HC1-Plus node should attach from the side of the chassis **away** from the terminal block. Run the wires to avoid obstructing airflow for the adjacent fans.

4. Repeat [Step 2](#) and [Step 3](#) for the other power supply module in the GigaVUE-HC1-Plus chassis.

## Connecting Serial Console and Mgmt Ports

**To make basic GigaVUE-HC1-Plus connections (serial console and Mgmt ports):**

1. Locate the DB9-to-RJ45 serial cable provided with the GigaVUE-HC1-Plus. This cable is called a *console cable*.



**NOTE:** This cable is Cisco-compatible. Refer to [Appendix D, Console Port Signaling and Cabling](#) for pinout details.

2. Connect the RJ45 end of the console cable to the **console** port on the left.
3. Connect the DB9 end of the console cable to a PC's COM port.
4. Connect a standard ethernet cable (Cat5e or better) to the 10/100/1000 **Mgmt** port on the chassis.
5. Connect the other end of the ethernet cable to an ethernet network.

## Configuring Basic GigaVUE® HC series Settings

This section describes how to perform the initial configuration of basic GigaVUE® HC series node settings over a serial terminal connection to the console port.

The system administrator must initially log in with a default **admin** account using a default password and then must immediately change the password through the **jump-start** script. Refer to [Access the Command-Line Interface over the Console Port](#).

Once you have used the console port to configure the Mgmt port's network properties, you can configure the GigaVUE® HC series node remotely using the Mgmt port's network connection.

The same commands are available in the GigaVUE-OS command-line interface regardless of whether you are connected over the Mgmt or console port.

### Access the Command-Line Interface over the Console Port

Use the console port on the left side of the base chassis to access the GigaVUE-HCI-Plus as follows:

1. Make the basic power and console cable connections described in [Connecting Serial Console and Mgmt Ports](#) and power on GigaVUE-HCI-Plus.
2. Start a terminal application on the PC. Common terminal applications include TeraTerm, PuTTY, and Hyperterminal.
3. Select the COM port connected to the console cable attached to control module. For example, **COM1**.
4. Configure the port settings for the console connection as follows:
  - o **Bits per second** – 115,200
  - o **Data bits** – 8

- o **Parity** – None
- o **Stop bits** – 1
- o **Flow control** – None

Figure 16 Setting COM Port Properties for the Console Connection shows an example of how these settings are configured in Hyperterminal.

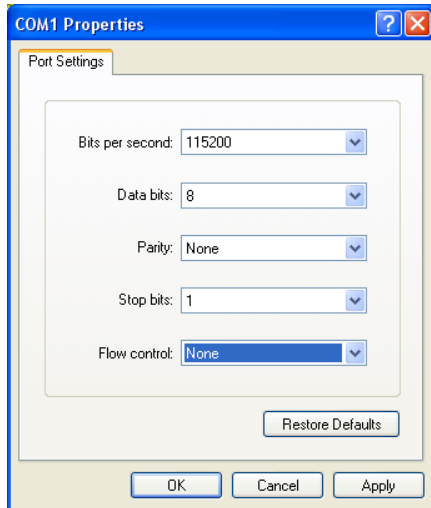

**Figure 16** Setting COM Port Properties for the Console Connection

5. Start the terminal connection. You may need to press **Enter** a few times before you see the **login:** prompt.
6. Log in to the command-line interface with the following default user account and password:

**User:admin**

**Password:admin123A!**

The **configuration jump-start** automatically starts and forces a password change. The system administrator must change the password on the default **admin** account through the **jump-start** script. The default password (admin123A!) is no longer allowed. Refer to [Run the Jump-Start Script](#) for details.

A password must meet the following standards:

- include 8-64 characters
- include at least one numeral
- include at least one upper-case letter
- include at least one lower-case letter
- include at least one special character (for example, !, @, #, \$, %, ^, &, or \* – ASCII 0x21, 0x2F, 0x3A, 0x40, 0x5B, 0x5F, 0x7B, 0x7E)
- Must not include the user name or parts of full name.

At the Admin password? prompt in the **jump-start** script, enter a new password that meets the standards, and then confirm the password.

## Run the Jump-Start Script

Gigamon provides GigaVUE HC Series nodes with a **jump-start** script that walks you through the process of configuring basic settings. Run this script as follows:

1. Switch to **Configure** mode.

The GigaVUE HC Series provides three command entry modes with increasingly powerful rights – **Standard**, **Enable**, and **Configure**. The jump-start script is only available in Configure mode:

- a. Type **en <Enter>** to switch to Enable mode.

The system prompts changes from **[hostname] >** to **[hostname] #**.

- b. Type **config t <Enter>** to switch to Configure mode.

The system prompts changes from **[hostname] #** to **[hostname] (config) #**.

2. Run the jump-start script with the following command:

**(config) # config jump-start**

3. Follow the jump-start script's prompts to configure the settings listed in the following table.

**NOTE:** If you change your mind about a particular setting, you will have a chance to change it at the end of the script.

<b>Hostname</b>	The hostname appears in the system prompt and is used to identify the chassis in SNMP traps.
<b>Management Port Network Settings</b>	Use either DHCP or specify a static IP address and netmask. If you do not use DHCP, you are prompted to configure the following additional options: <ul style="list-style-type: none"> <li>■ <b>Default Gateway</b> Supply the IP address of the default gateway for the node.</li> <li>■ <b>DNS Server</b> Supply the IP address of the DNS server for the node. A valid DNS server is required for successful use of TACACS+.</li> <li>■ <b>Domain Name</b> Supply the domain name for the node (for example, mycompany.com).</li> </ul>
<b>Enable IPv6?</b>	You can enable the use of IPv6 for the management port. IPv6 is used in addition to IPv4 if you enable this option. If you enable the IPv6, you have the option of enabling IPv6 auto-configuration or specifying a static address.

<b>Security Settings</b>	<p>Enable the following security settings:</p> <ul style="list-style-type: none"> <li>■ <b>secure cryptography mode</b></li> <li>■ <b>secure passwords mode</b></li> <li>■ <b>minimum password length</b></li> </ul> <p>Refer to the <b>GigaVUE-OS CLI Reference Guide</b> for security information .</p>
<b>Admin Password</b>	<p>The password for the <b>admin</b> account must be changed to a non-default password.</p>
<b>Cluster Enable?</b>	<p>Enable cluster support if this node will be a part of a cluster of connected GigaVUE HC Series nodes. If you enable cluster support, the jump-start script prompts you to supply the <b>Cluster ID</b>, <b>Cluster Name</b>, and <b>Cluster Mgmt Virtual IP Address</b>. You can join an existing cluster by supplying values that match existing settings.</p> <div style="border: 1px solid #ccc; padding: 5px; margin: 10px 0;"> <p><b>NOTE:</b> For clustered nodes configured to use the eth1 port on a control card as both the Mgmt and Cluster Management port, keep in mind that NTP is also used over the eth0 Mgmt port on the GigaVUE HC Series node. In a case like this, you can only use one or the other.</p> </div> <p>If clustering is enabled, you will not be prompted for a box ID in the next step.</p> <p>Refer to the <i>GigaVUE-OS CLI Reference Guide</i> for information on setting up a cluster.</p>
<b>Box ID for the Node</b>	<p>Supply a numerical box ID for the node. This box ID is used to identify network/tool ports in the node – the format is box ID/ slot ID/port ID.</p> <p>You will only be prompted for a box ID if clustering was not enabled in the previous step.</p>

4. Review your settings. You can change a setting by specifying its listed line number and re-entering the setting.
5. When you are satisfied with your settings, exit the script as prompted. GigaVUE HC Series automatically saves your settings.
6. Restart the node with the **reload** command.

## Need to Change Any Settings?

If you need to change any of the settings you made in the jump-start script, you can either run the script again or change individual settings using the following commands in the Configure command mode:

- Use the **hostname** command to change the node's hostname.

- Use the **interface eth0** command to reconfigure or fine-tune Mgmt port settings, including basic IP settings (DHCP or static address and subnet mask) and physical parameters (duplex, MTU, and speed).
- Use the **ip** command to change the default gateway, DNS server, and domain name.
- You can also use the **username admin password <password>** command to change the **admin** user's password.

Refer to [The Basic Commands](#) for a quick summary of the available GigaVUE HC Series commands.

## Configure Modules and Enable Ports

Modules must be configured and ports enabled before they can be used on the GigaVUE-HCI-Plus. Use the following procedure to bring up all modules and enable ports before starting to issue commands in the CLI:

1. Connect to the console port as described in the previous section.
2. Wait at least two minutes after the system prompt appears for the modules to be initialized, and then switch to **Configure** mode.

The GigaVUE® HC series provides three command entry modes with increasingly powerful rights – **Standard**, **Enable**, and **Configure**. The jump-start script is only available in Configure mode:

- a. Type **en <Enter>** to switch to Enable mode.

The system prompts changes from **[hostname] >** to **[hostname] #**.

- b. Type **config t <Enter>** to switch to Configure mode.

The system prompts changes from **[hostname] #** to **[hostname] (config) #**.

3. Reset the terminal settings to match the current window with the following command:

**(Config) # terminal resize**

4. Use the following command to check module status:

**(Config) # show cards**

5. Verify the following in the **show cards** output:
  - **Box ID** is not empty.
  - **Config** shows **yes** for all cards.
  - **Oper Status** shows **up** (or **inserted**) for all modules.
6. If **Config** does not show **yes** for all modules after two minutes, take the action corresponding to your **show cards** output as follows:

show cards Output:	Corrective Action
<b>Config</b> does not show <b>yes</b> for any modules (including base chassis)	<b>(config) # chassis box-id &lt;integer&gt;(config) # card all</b>
<b>Config</b> shows <b>yes</b> for base chassis but not one or more modules	<b>(config) # card all</b>

The **card all** command configures the node for all currently unconfigured modules. However, it can only be used after the node's box ID has been configured as reported at the top of the **show cards** command output.

- Use the **show cards** command again to verify the output.

The **show cards** command output for a GigaVUE-HCI-Plus displays the properly configured modules.

```

HC1P (config) # show cards
Box ID: 1
Slot  Config      Oper Status  HW Type          Product Code
Serial Num      HW Rev
-----
cc1  yes          up          HC1P-Main-Board  132-00GW
1GW0-006E      3.1-07
1    yes          up          HC1P-C04X08     132-00GZ
1GZ0-006E      1.2-7
2    yes          up          PRT-HC1-X12     132-00EK
1EK0-029C      A3-88
3    yes          up          PRT-HC1-X12     132-00EK
1EK0-000D      2.0-88
4    yes          up          SMT-HC1A-R      132-00GX
1GX0-007A      3.1-7

```

- Issue a **show port** command to determine the port numbers that need to be enabled.
- Use the **port** command with the **admin** argument to enable ports on modules as well as ports on the base chassis. For example, the following command enables all ports on the 10Gb ports on the base chassis:

```
(config) # port 1/1/x1..x8 params admin enable
```

- Save your changes so that the cards and ports come up automatically at the next reboot:

```
(config) # write memory
```

## Command-Line Basics

This section provides a quick orientation to the GigaVUE-OS command-line interface – how to enter commands, get help, and so on.

## Command-Line Modes

The GigaVUE-OS can operate in one of three modes, each with its own set of available commands – Standard, Enable, and Configure. When you first launch the CLI, you start in Standard mode with access to a limited number of commands to review node status. As you move from **Standard** mode to **Enable** mode to **Configure** mode, the power and the number of commands available increase, as summarized in [Figure 17 GigaVUE-OS Command-Line Modes](#).

### Differences in Commands for admin and default Level Users

The commands available in the GigaVUE-OS differ depending on whether you are logged in as **admin** or **default** level user. Commands listed in bold in [Figure 17 GigaVUE-OS Command-Line Modes](#) are only available to **admin** level users.



Figure 17 GigaVUE-OS Command-Line Modes



**NOTE:** If you are working simultaneously with multiple GigaVUE HC Series nodes, you may want to assign each a separate hostname so its easy to identify separate terminal sessions from the system prompt. Admin users can do this in Configure mode with the **hostname <name>** command.

## Entering Commands in the CLI

The GigaVUE-OS provides several conventions that make it easy to identify available commands and enter them quickly:

Technique	Description
Context-Sensitive Help	<p>The <b>?</b> symbol is the key to receiving help wherever you are in the CLI:</p> <ul style="list-style-type: none"> <li>Type <b>?</b> by itself to see a list of all available commands.</li> <li><b>Word Help</b> – Type a partial word with <b>?</b> mark immediately following the partially-typed word to see a list of all possible commands using the word entered so far. For example, if you typed <b>r?</b> in Configure mode, the CLI would return the following possible commands based on what you have entered so far: <b>radius-server Configure RADIUS server settings reload Reboot or shut down the system reset Reset this system to its factory state</b></li> <li><b>Command Help</b> – Type a command followed by a question mark to see all possible arguments for the command as entered. If the node returns <b>&lt;cr&gt;</b>, that means the command can be entered as-is. For example, if you entered <b>gigastream ?</b>, you would see <b>alias</b>. You can build your way through the entire command tree by entering <b>?</b> after each new argument. For example, after entering <b>gigastream alias myalias ?</b>, you would see the next valid argument – <b>port-list</b>.</li> </ul> <p><b>NOTE:</b> Typing <b>?</b> accesses the help system immediately – you do not need to press <b>&lt;Enter&gt;</b>.</p>
Partial Command Entry	<p>For all GigaVUE HC Series commands and arguments, you only need to enter enough characters to distinguish the command from all other available commands. So, for example, you do not have to enter the full command <b>debug</b> – there is only one command starting with the letter <b>d</b>, so you only have to enter <b>d</b>.</p>
Command Completion	<p>If you have partially typed a command, you can press <b>Tab</b>, and the CLI will attempt to complete the command based on what has been entered so far.</p>

Technique	Description
	<p>Use the command completion feature with partial command entry – you can press Tab while entering a command to see a list of all available commands matching what you have entered so far. For example, you can press <b>p&lt;Tab&gt;</b> and the node will return:</p> <p><b>ping ping6 port port-group port-pair ptp</b></p> <p>Based on this information, you only need to enter <b>pt</b> to distinguish the <b>ptp</b> command from the other commands beginning with the letter <b>p</b>.</p>

## Command-Line Syntax – Entering Commands

You enter all configuration commands for the GigaVUE-OS in the command-line interface. Enter commands by typing enough characters to uniquely identify the command and pressing **<Enter>**.

When entering commands, keep in mind the following rules:

- Successful commands return no response in the CLI; commands with errors return an error response beginning with **%**, followed by a short error description.
- All commands are case-sensitive.
- Aliases are case-sensitive and accept both lower and upper case – for example, **my\_alias** and **My\_Alias** refer to two separate maps.
- The **no** command is used to remove configuration settings. For example, **no connect alias myconnect** deletes the named **myconnect**.
- Port numbers are entered in **<chassis-id>/<slot-num>/<port-num>** format. For example, **1/1/x1** identifies the 1Gb/10Gb port x1 in slot 1 on box 1.
- Strings must consist entirely of alphanumeric characters with no spaces. The only exceptions are the underscore (**\_**) and hyphen (**-**) characters. Those are allowed.

For example, in Configure mode, **port 1/1/x1 alias My\_Alias** is legal, but **port 1/1/x1 alias My Alias** is not.

**NOTE:** Some string fields do accept spaces provided the input is made inside quotation marks (for example, the **banner login** command described in [Using a Custom Banner](#)).

## Configure Mode Syntax

Users of GigaVUE® HC series nodes may be accustomed to entering the word **config** before many commands – **config map**, **config port-filter**, and so on. When using the GigaVUE-OS, the “config” part of the command is implied whenever you are working in Configure mode. The system prompt helps you remember this by including the word **(config)** in parentheses. For example:

```
(config) #
```

So, instead of entering **config gigastream** to set up a GigaStream consisting of multiple ports, you just enter **gigastream** followed by the necessary arguments. The **config** part is implied because you are already working in the Configure mode. For example:

```
(config) # gigastream alias mystream port-list 1/1/x1..x4
```

## Paging through CLI Output

By default, the CLI returns output exceeding the configured terminal length in pages. The CLI provides the same features for working through the paged output as the Linux programs **less** and **more**. Press the **h** key when presented with the paging prompt at the base of the display to see paging options – [Figure 18 Viewing Paging Options](#) provides an example of how to do this.

If you prefer, you can disable paging either for the current session or by default:

- **Disable for Current Session**(config) # no cli session paging enable
- **Disable for All Sessions (Default)**(config) # no cli default paging enable

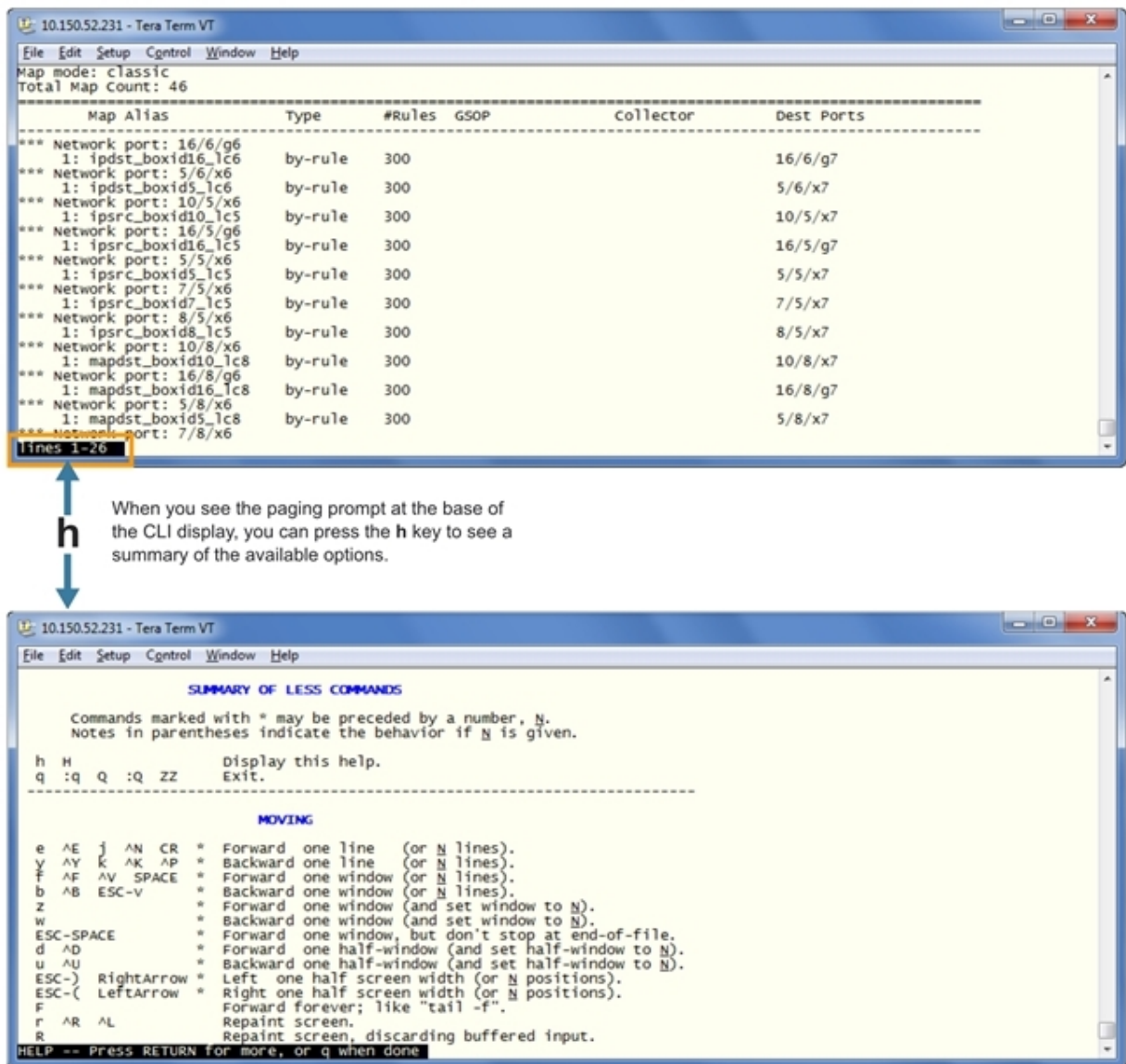

Figure 18 Viewing Paging Options

# Command-Line Syntax – Entering Commands

You enter all configuration commands for the GigaVUE-OS in the command-line interface. Enter commands by typing enough characters to uniquely identify the command and pressing **<Enter>**.

When entering commands, keep in mind the following rules:

- Successful commands return no response in the CLI; commands with errors return an error response beginning with %, followed by a short error description.

- All commands are case-sensitive.
- Aliases are case-sensitive and accept both lower and upper case – for example, **my\_alias** and **My\_Alias** refer to two separate maps.
- The **no** command is used to remove configuration settings. For example the **no connect alias myconnect** deletes the named **myconnect**.
- Port numbers are entered in **<chassis-id>/<slot-num>/<port-num>** format. For example, **1/1/x1** identifies the 10Gb/1Gb port x1 in slot 1 on box 1.
- Strings must consist entirely of alphanumeric characters with no spaces. The only exceptions are the underscore (\_) and hyphen (-) characters. Those are allowed.  
For example, in Configure mode, **port 1/1/g1 alias My\_Alias** is legal, but **port 1/1/g1 alias My Alias** is not.

**NOTE:** Some string fields do accept spaces provided the input is made inside quotation marks (for example, the **banner login** command described in [Using a Custom Banner](#)).

## Configure Mode Syntax

Users of GigaVUE HC Series nodes may be accustomed to entering the word **config** before many commands – **config map**, **config port-filter**, and so on. When using the GigaVUE-OS, the “config” part of the command is implied whenever you are working in Configure mode. The system prompt helps you remember this by including the word **(config)** in parentheses. For example:

**(config) #**

So, instead of entering **config gigastream** to set up a GigaStream consisting of multiple ports, you just enter **gigastream** followed by the necessary arguments. The **config** part is implied because you already work in the Configure mode. For example:

**(config) # gigastream alias mystream port-list 1/1/x1..x4**

## Paging through CLI Output

By default, the CLI returns output exceeding the configured terminal length in pages. The CLI provides the same features for working through the paged output as the Linux programs **less** and **more**. Press the **h** key when presented with the paging prompt at the base of the display to see paging options – [Figure 19 Viewing Paging Options](#) provides an example of how to do this.

If you prefer, you can disable paging either for the current session or by default:

- **Disable for Current Session**(config) # no cli session paging enable
- **Disable for All Sessions (Default)**(config) # no cli default paging enable

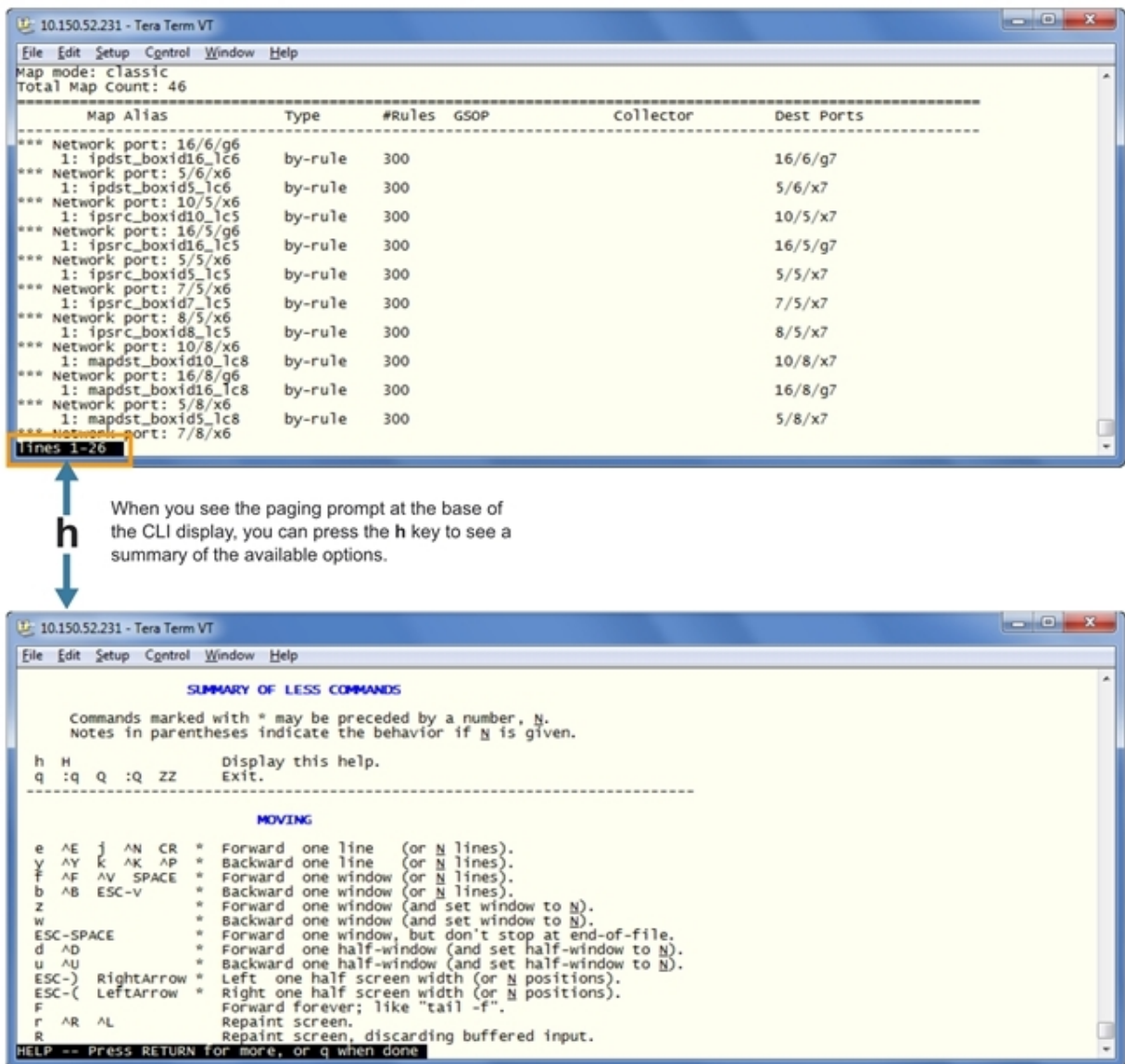

Figure 19 Viewing Paging Options

## The Basic Commands

The following table lists each of the top level commands for the GigaVUE-OS in Configure mode. As described in [Entering Commands in the CLI](#), the commands available in Configure mode are a superset of those available in Standard and Enable modes.

Most commands have multiple supported arguments. You can see the exact arguments available at any point of command entry by typing it into the CLI followed by **?**.

Table 3: CLI Commands

Command	Description
<b>aaa</b>	Configures authentication, authorization, and accounting setting
<b>apps</b>	Enables access to Gigamon Applications, such as Application Session Filtering (ASF), GTP backup, GTP whitelisting, inline SSL/TLS decryption, keystore, NetFlow, SIP whitelisting, and Passive SSL decryption. GigaSMART applications are not supported on the GigaVUE TA Series.
<b>banner</b>	Sets a node login banner.
<b>bond</b>	Configures bonded interface settings.
<b>boot</b>	Configures node boot parameters.
<b>card</b>	Configures a line card or module.
<b>chassis</b>	Configures the GigaVUE HC Series chassis.
<b>clear</b>	Resets statistics or clears caches.
<b>cli</b>	Configures CLI shell options.
<b>clock</b>	Sets the node clock or timezone.
<b>cluster</b>	Configures a cluster of connected GigaVUE-OS nodes.
<b>configuration</b>	Manages configuration files.
<b>configure</b>	Enter Configure mode.
<b>coreboot</b>	Installs new core boot software.
<b>crypto</b>	Manages X.509 certificates for the GigaVUE HC Series node's Web server.
<b>debug</b>	Generates a dump file for use in debugging issues with Gigamon Technical Support.
<b>disable</b>	Exits Enable mode and returns to Standard mode.
<b>email</b>	Configures email and event notification via email.
<b>enable</b>	Enters Enable mode.
<b>exit</b>	Exits Configure mode and returns to Enable mode or logs out of the CLI.
<b>file</b>	Manages TCP and debug dump files on disk.
<b>filter-template</b>	Configures flexible filter templates on GigaVUE-HC3 and GigaVUE-TA100.
<b>gigasmart</b>	Configures an interface address to a GigaSMART card or node.
<b>gigastream</b>	Configures a GigaStream—a group of ports acting as a single addressable tool port destination or stack-link.
<b>gsgroup</b>	Configures a GigaSMART group consisting of one or more internal GigaSMART ports.
<b>gsop</b>	Configures a GigaSMART operation consisting of one or more advanced processing applications.
<b>gsparams</b>	Configures GigaSMART parameters.
<b>halt</b>	Shuts down the node without powering it off.
<b>hb-profile</b>	Configures a heartbeat profile on GigaVUE HC Series nodes.
<b>help</b>	Views a description of the interactive help system.
<b>hostname</b>	Specify the node's hostname. The hostname appears in the system prompt and in SNMP traps.
<b>ib-pathway</b>	Reserved for future use.
<b>image</b>	Manages node software images.



Command	Description
<b><i>inline-network</i></b>	Configures an inline network on GigaVUE HC Series nodes.
<b><i>inline-network-group</i></b>	Configures an inline network group on GigaVUE HC Series nodes.
<b><i>inline-netlag</i></b>	Configure Inline-Netlag.
<b><i>inline-serial</i></b>	Configures an inline tool series on GigaVUE HC Series nodes.
<b><i>inline-tool</i></b>	Configures an inline tool on GigaVUE HC Series nodes.
<b><i>inline-tool-group</i></b>	Configures an inline tool group on GigaVUE HC Series nodes.
<b><i>interface</i></b>	Configures network interfaces.
<b><i>ip</i></b>	Configures IP settings for the eth0 Mgmt port.
<b><i>ipv6</i></b>	Configures IPv6 settings for the eth0 Mgmt port.
<b><i>job</i></b>	Configures scheduled jobs.
<b><i>ldap</i></b>	Configures LDAP server settings for authentication.
<b><i>license</i></b>	Activates features using license keys. Licensing is used for GigaSMART, Port, or Advanced Features License.
<b><i>logging</i></b>	Configures event logging.
<b><i>map</i></b>	Configures maps and map rules to manage GigaVUE HC Series traffic distribution.
<b><i>map-group</i></b>	Configures map groups for GTP forward listing and GTP flow sampling.
<b><i>map-passall</i></b>	Creates a pass-all map to send all traffic on a network port to a tool port irrespective of the other packet distribution in place on the port.
<b><i>map-collector</i></b>	Configures shared collector map parameters.
<b><i>map-template</i></b>	Configures a map template.
<b><i>nhb-profile</i></b>	Configures a negative heartbeat on GigaVUE HC Series nodes.
<b><i>no</i></b>	Deletes or clears certain configuration options.
<b><i>notifications</i></b>	Configures notification settings.
<b><i>ntp</i></b>	Enables and disables the use of NTP, as well as adds NTP servers.
<b><i>ntpdate</i></b>	Sets node clock once from a remote server using NTP.
<b><i>ping</i></b>	Sends ICMP echo requests to a specified host.
<b><i>ping6</i></b>	Sends IPMPv6 echo requests to a specified IPv6 host.
<b><i>pld</i></b>	Upgrades programmable logic devices (PLDs) on GigaVUE-HC3 nodes.
<b><i>policy</i></b>	Configures an Active Visibility policy.
<b><i>port</i></b>	Configures port type, parameters, and filters.
<b><i>port-group</i></b>	Creates a group of ports.
<b><i>port-pair</i></b>	Configures a port-pair on a pair of network ports within the same GigaVUE HC Series node. A port-pair is a bidirectional connection in which traffic arriving on one port in the pair is transmitted out the other (and vice-versa) as a pass-through TAP.
<b><i>ptp</i></b>	Enables and disables the use of PTP.
<b><i>radius-server</i></b>	Configures RADIUS server settings for authentication.



Command	Description
<b><i>redundancy-profile</i></b>	Configures an inline redundancy profile on GigaVUE HC Series nodes.
<b><i>reload (reboot)</i></b>	Reboots or shuts down the node.
<b><i>rename</i></b>	Renames the map alias.
<b><i>reset</i></b>	Resets specified portions of the node configuration to their factory states.
<b><i>serial</i></b>	Sets options for the serial console port.
<b><i>sfp</i></b>	Reserved for future use.
<b><i>sffp</i></b>	Configure Subscriber Flow Forwarding Protocol profile
<b><i>show</i></b>	Displays configuration and status information for GigaVUE HC Series settings and entities.
<b><i>sleep</i></b>	Sleeps for a specified number of seconds.
<b><i>snmp-server</i></b>	Configures SNMP settings, including the local SNMP server, notification events, and notification destinations.
<b><i>spine-link</i></b>	Configures spine links in a cluster with a leaf and spine architecture.
<b><i>ssh</i></b>	Enables and disables SSH access, as well as manages settings.
<b><i>stack-link</i></b>	Configures a stack-link between two GigaVUE HC Series nodes in a cluster. Stack-links are used to carry data traffic between nodes in a GigaVUE HC Series cluster.
<b><i>sync</i></b>	Enables dynamic control card synchronization for a GigaVUE HC Series node.
<b><i>system</i></b>	Changes system settings.
<b><i>system-health</i></b>	Configures system health behaviors.
<b><i>tacacs-server</i></b>	Configures TACACS+ server settings for authentication.
<b><i>tcpdump</i></b>	Display packets on a network.
<b><i>terminal</i></b>	Sets terminal parameters, including width and length.
<b><i>timestamp</i></b>	Configures the timestamp source.
<b><i>tool-mirror</i></b>	Configures a tool-mirror connection between two tool ports. A tool-mirror connection sends all packets arriving on one tool port to a second tool port on the same node.
<b><i>traceroute</i></b>	Traces the route packets take to a destination.
<b><i>tunnel</i></b>	Reserved for future use.
<b><i>tunnel-endpoint</i></b>	Configures a tunnel endpoint, which is a destination for load-balanced traffic from an L2GRE encapsulation tunnel.
<b><i>tunneled-port</i></b>	Configures a tunnel port to be used for GigaSMART encapsulation/decapsulation operations.
<b><i>uboot</i></b>	Installs new uboot software.
<b><i>username</i></b>	Manages user accounts.
<b><i>vport</i></b>	Configures a virtual port.
<b><i>web</i></b>	Configures the Web server used for GigaVUE-FM GUI support on the GigaVUE HC Series node.
<b><i>write</i></b>	Saves the running configuration to persistent storage.

# Completing the Initial GigaVUE® HC series Setup

At this point, you have logged in to the GigaVUE-OS command-line interface using the **admin** account, configured the **Mgmt** port's network properties for SSH access, and have explored the command-line interface structure.

There are a few more steps you should perform to complete the initial configuration before you get to the fun stuff – setting up network ports, tool ports, and mapping traffic. These tasks include:

- Switch to the Configure mode. Refer to [Enter the Configure Command-Line Mode](#).
- Configure SSH access to the node. Refer to [SSH](#).
- Configure the GigaVUE® HC series time and date options. Refer to [Configuring GigaVUE® HC series Time Options](#).
- Configure automatic email notifications for node events. Refer to [Configuring Automatic Email Notifications](#).
- Configure a custom login banner. Refer to [Using a Custom Banner](#).
- Save your changes!. Refer to [Saving Changes](#).

## Enter the Configure Command-Line Mode

Keep in mind that the GigaVUE-OS has three different command modes for the CLI – **Standard**, **Enable**, and **Configure**. The commands described in the following sections are all only available in Configure mode. Switch to Configure mode as follows:

Command	Notes
<b>&gt; enable</b>	You only need to supply enough of each command to positively identify it among the other available commands. So, in this example, you could just type <b>ena</b> and press Enter.
<b># configure terminal</b>	Similarly, this command can be entered as <b>co t</b> .
<b>(config) #</b>	Notice how the system prompt changes with each command mode. Command modes offer greater control over the node as you ascend from <b>Standard</b> to <b>Enable</b> to <b>Configure</b> .

# SSH

SSH2 is available for remote connections to the GigaVUE-HCI-Plus's **Mgmt** port. By default, SSH2 is enabled. Use the **ssh** commands in Configure mode to enable or disable the corresponding connections. To disable the corresponding connection, you include **no** before the command, as demonstrated in the following table. For example:

Command	Notes
Enable: <b>(config) # ssh server enable</b> Disable: <b>(config) # no ssh server enable</b>	When SSH2 is enabled, use any compliant SSH2 client to connect to the command-line interface remotely. For example, to connect using the popular SSH2 client, PuTTY: <ol style="list-style-type: none"> <li>Start PuTTY and enter the GigaVUE® HC series node's IP address in the Host Name field.</li> <li>Click the <b>SSH</b> protocol radio button.</li> <li>Click <b>Open</b> to open a connection. If this is your first connection PuTTY warns you that the host key presented by the GigaVUE® HC series node is not in your cache. You can add the key, connect without adding the key, or cancel the connection. Refer to <a href="#">Verifying Host Keys During Connection</a> for information on how to verifying that the host key shown is correct.</li> <li>Log in with GigaVUE® HC series credentials.</li> </ol>

## Advantages of SSH2

SSH2 is a secure choice for remote connections, providing an encrypted channel instead of relying on clear text. It also provides stronger user authentication capabilities, including the use of a public **host key**. Host keys uniquely identify a server, helping guarantee that you are connecting to the server you think it is.

GigaVUE® HC series includes default RSA v1/v2 and DSAv2-encrypted public host keys (SSH2 supports both RSA and DSA encryption algorithms). The first time you connect to GigaVUE® HC series with an SSH2 client, the client will warn you that the host keys are not in your local cache and show you the actual host key presented by the GigaVUE-HCI-Plus. Your client will most likely give you the option of trusting the key and adding it to your local cache. Once you have trusted the key, your client will alert you during a connection if a different key is presented.

### Verifying Host Keys During Connection

To verify that the host key presented during an SSH2 connection is in fact, the GigaVUE® HC series node's, you can connect over the console port (refer to [Access the Command-Line Interface over the Console Port](#)) and use the **show ssh server host-keys** command to see the current public host keys and fingerprints for the GigaVUE-HCI-Plus. Paste these in a file

and keep them nearby when you connect via SSH2 the first time. This way, you will be able to compare the actual host key to what your SSH2 client says is being presented. Once you have verified that they are the same, you can choose to trust the host key, allowing future connections to take place seamlessly.

## Changing Host Keys

Use the **ssh server host-key generate** command to change the default host keys provided with the GigaVUE-HCI-Plus. The command has the following syntax:

```
ssh server host-key <rsa1 | rsa2 | dsa2> <private-key | public-key> generate
```

For example, to configure a new RSAv1 public hostkey, you could use the following command:

```
(config) # ssh server host-key rsa1 public-key generate
```

## Connecting to the GigaVUE<sup>®</sup> HC series Node from GigaVUE-FM

Use the following procedure to connect to a GigaVUE<sup>®</sup> HC series node using GigaVUE-FM.

**NOTE:** You can configure whether the GigaVUE<sup>®</sup> HC series node redirects all incoming HTTP connections to the HTTPS port with the **web http redirect** command.

1. Open a supported browser. Refer to the **GigaVUE Fabric Management Guide**.
2. Enter one of the following URLs:
 

```
https://<GigaVUE® HC series Node IP Address>http://<GigaVUE® HC series Node IP Address>
```
3. The first time you connect to GigaVUE-FM, your browser will prompt you regarding an invalid security certificate. Depending on the browser you are using and you can avoid these warnings either by installing a certificate or adding an exception. The following table has the details:

Browser	Add Exception?	Install Certificate?
Mozilla Firefox	Y	Y
Windows Internet Explorer	N	Y
Apple Safari		
Google Chrome		

**NOTE:** Gigamon provides the GigaVUE® HC series with self-signed certificates for use with GigaVUE-FM; you can also create and install a third-party certificate on these nodes.

Add an exception in Firefox as follows:

- a. Click the **Or you can add an exception** link.
- b. Click the **Add Exception** button.
- c. Click the **Get Certificate** button.
- d. Click the **Confirm Security Exception** button.

The GigaVUE-FM login page appears.

4. Enter a valid username and password and click **Login**.

### Configuring Internet Explorer for Use with GigaVUE-FM

GigaVUE-FM works best in Internet Explorer when the browser is configured to check for newer versions of stored pages every time pages are visited. Enable this option as follows:

1. Open Internet Explorer.
2. Select the **Tools > Internet Options** command.
3. In the **General** tab, locate the **Browsing history** section and click its **Settings** button.
4. Set the **Check for newer version of stored pages:** option to **Every time I visit the webpage**.
5. Click **OK** on the Temporary Internet Files and History Settings dialog.
6. Click **OK** on the Internet Options dialog.

### Next Steps?

Refer to the online help for details on configuring and operating the GigaVUE-HCI-Plus from the GigaVUE-FM interface. Keep in mind that each of the initial configuration settings described in the rest of this chapter can also be set in GigaVUE-FM.

## Configuring GigaVUE® HC series Time Options

The GigaVUE® HC series node includes a variety of features for setting the time, including:

Method	CLI Command	For more information:
System Clock	<code>clock set hh:mm:ss yyyy/mm/dd</code>	<a href="#">Setting Time Manually</a>
One-Time NTP	<code>ntpdate &lt;ntpserver</code>	<a href="#">Performing One-Time NTP Server Synchronization</a>

Method	CLI Command	For more information:
Synchronization	<b>address&gt;</b>	
Persistent NTP Synchronization	Add server using <b>ntp server</b> command. Enable use of ntp with <b>ntp enable</b> command.	<a href="#">Using NTP Time Server for Clock Synchronization</a>
PTP Synchronization	Enable PTP with <b>ptp enable</b> command.	<i>Refer to the GigaVUE-OS CLI Reference Guide (Reserved for future use)</i>

## Setting Time Manually

The easiest way to set the GigaVUE® HC series node's time is manually with the **clock set** command. For example:

```
(config) # clock set 05:18:38 2015/01/06
```

**NOTE:** Even if you are using NTP, configure time manually as well. The GigaVUE® HC series node will automatically fall back to the manual time setting if it is unable to synchronize with the specified time server.

The **show ntp** command shows the current state of the NTP server in use; the **show clock** command shows the current GigaVUE® HC series node's time.

## Performing One-Time NTP Server Synchronization

You can perform a one-time synchronization with an NTP server using the **ntpdate** command. For example:

```
(config) # ntpdate time.nist.gov
```

**NOTE:** This method does not provide updates to correct clock drift over time. It is generally preferable to use persistent NTP synchronization with the **ntp** commands.

## Using NTP Time Server for Clock Synchronization

The GigaVUE® HC series node can optionally use one or more NTP servers for its time setting. Use the following procedure to add an NTP server to the GigaVUE® HC series node's list and enable the use of NTP.

1. Specify the address of the time server. For example, if the time server is on 192.168.1.10, you would use the following command:

```
(config) # ntp server 192.168.1.10
```

**NOTE:** There are many public NTP servers available on the Internet.

2. Turn on NTP with the following command:

**(config) # ntp enable**

- The GigaVUE® HC series node connects to the specified NTP server and synchronizes to its time.
- NTP reports times in UTC. Because of this, it is a good idea to specify the GigaVUE® HC series node's timezone so that UTC can be converted to the local timezone.

You specify the timezone either in terms of the offset from UTC (either plus or minus) or with a particular location's name, depending on the argument you choose for the **clock timezone** command:

- Offset from UTC** – Set the timezone as an offset from UTC with the **UTC-offset** argument. For example, the following command sets the timezone as eight hours earlier than UTC:  
**(config) # clock UTC-offset UTC-8**
- Location** – You can specify a particular location's timezone to use. The easiest way to do this is to build the available list of cities by adding a space and a question mark after each subsequent zone word. For example, enter **(config) # clock timezone ?** to see the list of available locations. Select a location and use the same question mark technique to see the next available zone words. This way, you can build out to the exact location you need. For example:

**(config) # clock timezone America North United\_States Pacific (config) # clock timezone Asia Eastern Hong\_Kong**

Once you have finished configuring NTP options, use the **show ntp** command to check the status of clock synchronization ([Configuring GigaVUE® HC series Time Options](#)).

```
GigaVUE (config) # show ntp
NTP is enabled.
Clock is synchronized. Reference: 69.25.96.13. Offset: -4.846 ms.
Active servers and peers:
-----
Address          Status          Stratum  Offset  Ref  Poll  Last
(msec)          (msec)          (msec)  (msec)  Clock  Interval  Response
                                     (sec)   (sec)
-----
69.25.96.13     sys.peer (*)    1        -4.846  .ACTS. 64      24
GigaVUE (config) #
```

**Figure 20** Checking NTP Status and Configuration

## Configuring Automatic Email Notifications

The GigaVUE HC Series node provides powerful email notification capabilities, automatically sending emails to specified addresses when any of a wide variety of events take place on the node. Gigamon strongly recommends that you configure this feature so you have immediate visibility of events affecting node health.

You configure automatic email notifications with the **email** command and its arguments. Start by making sure the CLI is in Configure mode. If the **(config)** entry appears in the

system prompt, you are in Configure mode. If not, use the **enable** and **configure terminal** commands sequentially to change to Configure mode. Then, configure email notifications as follows:

Description	Command
<p>First, use the <b>email mailhub</b> command to specify the mail server to use for notification emails. In this example, we are using the email server named <b>smtp.emailsrvr.com</b>. You could also supply an IP address instead of a hostname.</p>	<pre>(config) # email mailhub smtp.emailsrvr.com</pre>
<p>Next, use the <b>email auth</b> command to supply the email account username and password. In this example, we are using <b>alerts@mycompany.com</b> with the password of <b>mypassword123</b>.</p>	<pre>(config) # email auth username alerts@mycompany.com (config) # email auth password mypassword123</pre>
<p>Now that we have set up the account to use, we will turn on email authentication.</p>	<pre>(config) # email auth enable</pre>
<p>Now that we have configured the settings that let the node send emails, set up who to send them to and when to send them. Use <b>email notify recipient</b> to configure the destinations for event notification emails. You can specify multiple destinations separated by commas with no spaces.</p>	<pre>(config) # email notify recipient cday@mycompany.com,mfelton@mycompany.com</pre>
<p>The <b>email notify event</b> command lets you configure which events will trigger automatic emails. There are quite a few events available – start by entering <b>email notify event ?</b> to see the list of available events. You can either enable individual events, or, use the <b>all</b> argument to enable them all. We are going to start with the <b>all</b> setting and tune settings as necessary later on.</p>	<pre>(config) # email notify event all</pre>



Description	Command
It is a good idea to check your settings and make sure emails are sent successfully. You can do that with the <b>email send-test</b> command. If you do not receive the email, check the <b>show log</b> output to make sure the email was sent. Then, reconfigure email settings, if necessary.	<b>(config) # email send-test</b>
You may also want to configure and enable <b>autosupport</b> emails. Autosupport emails are sent directly to Gigamon's Technical Support department when specified events take place, enabling proactive problem resolution. The GigaVUE HC Series node is preconfigured with the correct destination address – you just need to enable the feature with the following command.  Use show email events to see the list of events for which auto support emails will be sent. You can change the list with the <b>(no) email autosupport event</b> command.	<b>(config) email autosupport enable</b>
Emails will now be sent automatically to the configured addresses when any selected events occur. There are many other options for fine-tuning automatic email settings, including how to handle “dead letters” (emails that did not reach their recipient), how the email address of the GigaVUE HC Series node should appear, the port for the email server, the reply-to address, and so on. Refer to the <b>GigaVUE-OS CLI Reference Guide</b> for details.	

## Using a Custom Banner

The GigaVUE HC Series node can display a customizable text banner at node startup before a user logs in. This way, users connecting to the node see the banner before they log in, giving them an idea of which node they are logging in to. The banner also appears after a user logs out.

Use the **banner login “<string>”** command to configure the login banner. For example:

```
(config) # banner login "Pacific Call Center"
```

**NOTE:** You only need to use quotation marks for the <string> if it includes spaces.

The next time you log in or out of the GigaVUE HC Series node, you will see the customizable banner.

## Saving Changes

It is a good idea to use the **write memory** command to save changes as you make them. Later on, when you start setting up packet distribution with connections and maps, your changes will be added to the active configuration right away but will not be saved across a node reboot unless you use the **write memory** command to save your changes to flash.

**NOTE:** The name of the factory-provided configuration file is **initial**. You can see the name of the most recently booted configuration file by using the **show running-configuration** command (or **show configuration**) and look for the **## Running database** entry. In [Figure 21 Showing the Current Configuration File](#), you can tell that the GigaVUE HC Series node is currently operating with the **initial** configuration file.

Refer to the **GigaVUE-OS CLI Reference Guide** for details on using configuration files.

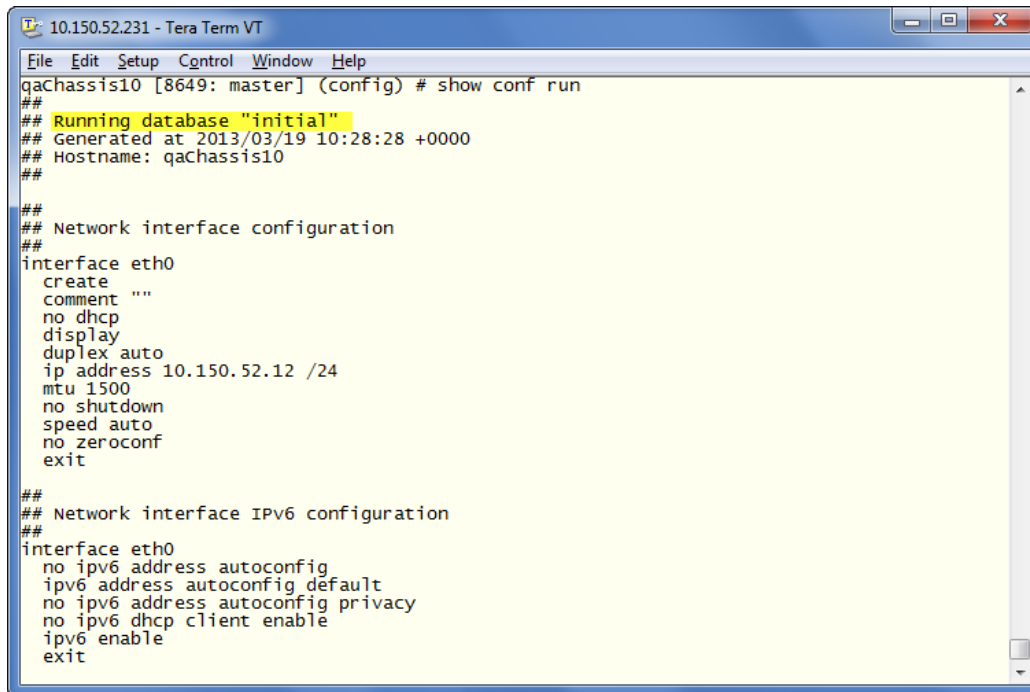

```

10.150.52.231 - Tera Term VT
File Edit Setup Control Window Help
qaChassis10 [8649: master] (config) # show conf run
##
## Running database "initial"
## Generated at 2013/03/19 10:28:28 +0000
## Hostname: qaChassis10
##
##
## Network interface configuration
##
interface eth0
  create
  comment ""
  no dhcp
  display
  duplex auto
  ip address 10.150.52.12 /24
  mtu 1500
  no shutdown
  speed auto
  no zeroconf
  exit
##
## Network interface IPv6 configuration
##
interface eth0
  no ipv6 address autoconfig
  ipv6 address autoconfig default
  no ipv6 address autoconfig privacy
  no ipv6 dhcp client enable
  ipv6 enable
  exit

```

**Figure 21** Showing the Current Configuration File

## Connecting GigaVUE-HC1-Plus Ports

This chapter describes transceivers and port connections. In general, connecting GigaVUE-HC1-Plus module ports to the network is as simple as installing a transceiver and connecting the correct cable to data sources or destinations. Refer to the following sections for details:

- [Transceiver—Rules and Notes](#)
- [Transceiver Installation Instructions](#)
- [Bypass Module Specifications](#)
- [Connecting GigaVUE-HC1-Plus Module Ports](#)

## Transceiver—Rules and Notes

Keep in mind the following rules and notes when you connect and use GigaVUE-HC1-Plus nodes with transceivers:

- Always use transceivers purchased from Gigamon to ensure interoperability and performance. Gigamon does not support transceivers purchased from other vendors.
- After removing an optical transceiver, the best practice is to wait seventeen (17) or more seconds before re-inserting the same or different optical transceiver. This includes the intervals between removal/insertion/re-insertion.
- Use the **show port params all** command to see transceiver type information for each of the network/tool ports in the GigaVUE-HC1-Plus node. Check the value of the **SFP type** field for the ports in question.
- Port numbers starting with x (for example, x10) are 10Gb or 1Gb, depending on the transceiver installed.

**NOTE:** For details about the supported transceivers, cable types, and connectivity specifications, refer to “*GigaVUE-OS Compatibility and Interoperability Matrix*”.

## Transceiver Installation Instructions

Gigamon transceivers are keyed and can only be installed in one direction. Transceivers are hot-swappable – they can be installed or removed with the power on or off. Use the following procedures to install and remove SFPs from GigaVUE® HC series modules.

**IMPORTANT:** Always use an ESD-preventive wrist or ankle strap and ensure that it makes good skin contact when installing or removing SFP/SFP+/SFP28 transceivers. The strap can be connected to one of the following:

- ESD wrist strap connector.
- Captive installation screws on an installed module or power supply module.
- Any unpainted surface on the chassis.

### Installing Transceivers

1. Remove the dust cap from the port and set it aside for future use.
2. Orient the transceiver with the opening in the module and insert it into the slot.
3. Push gently but firmly until the transceiver is seated in the slot.
4. Close the latch on the SFP to lock it into the slot.

### Removing Transceivers

1. Disconnect the cable (if any) from the transceiver.
2. If you are removing a fiber-optic transceiver, install dust caps in the transceiver to protect the optical interfaces.

3. Open the latch on the transceiver and gently remove it from the slot.
4. If you are not installing a new transceiver, install a dust cap in the open slot on the module.

## Copper TAP Specifications

Refer to [Table 4: Internal Transceiver Specifications for Copper TAPs](#) for specifications for copper TAPs.

Table 4: Internal Transceiver Specifications for Copper TAPs

Module Type	Transceiver Type	Speed	Auto Negotiation	Duplex
<b>TAP-HC1-G10040 Copper (RJ45)4 TAP Module</b>	N/A	10/100/1000Mb	Always ON	Full

## Bypass Module Specifications

Refer to [Table 5: Internal Transceiver Specifications for Bypass Combo Modules](#) and [Table 6: Loss Summary per Bypass Combo Modules](#) for internal transceiver specifications and loss summaries for bypass modules.

Table 5: Internal Transceiver Specifications for Bypass Combo Modules

Module Type	Transceiver Type	Speed	Auto Negotiation	Duplex
<b>BPS-HC1-D25A60 SX/SR</b>	QSF-507T	40G	Always OFF	Full
<b>BPS-HC1-D35C60 LX/LR</b>	QSF-506T	40G	Always OFF	Full
<b>BPS-HC1-D25A24SX/SR 50/125</b>	SFP+ 1Gb/10Gb Dual Rate 850nm MM	1000Mbps (1Gbps)/10000Mbps (10Gbps)	Always OFF	Full

Table 6: Loss Summary per Bypass Combo Modules

Type	@	Operating Wavelength (nm)			Cable Type	Max Fiber Length	Max Receiver Sensitivity	Insertion Loss
		Min	Typical	Max				LC to LC (dB)
BPS-HC1-D25A24SX/SR 50/125	1Gb	840	850	860	LC	550m	-17	1.2
	10Gb	840	850	860	LC	82m	-11.1	1.2
BPS-HC1-D25A60 SX/SR	40Gb	840	850	860	LC UPC to LC UPC Multi-mode	100m	-11.1 dBM	1.2
BPS-HC1-D35C60 LX/LR	40Gb	1260	1310	1360	LC APC to LC APC Single Mode	6km	-12.6 dBM	1.5

## Connecting GigaVUE-HC1-Plus Module Ports

Connecting network and tool ports on GigaVUE-HC1-Plus base chassis ports and modules is generally as simple as connecting a cable between the source/destination device and the GigaVUE-HC1-Plus port. You just need to make sure that the modules and ports on the GigaVUE-HC1-Plus node are enabled and that their parameters are configured correctly. Refer to the following sections for details:

- [Enabling Modules and Ports](#) – Make sure that the modules and ports you want to use are enabled. Newly installed modules must be configured with the **card** command and their ports enabled with **port <port-list> params admin enable**.
- [Setting Port Parameters Manually](#)- If both ends of the connection are using autonegotiation, no manual configuration is typically necessary. However, if autonegotiation is not used (or is not successful), you can use these instructions to configure port parameters manually.

## Enabling Modules and Ports

Use the following procedure to ensure that all modules are configured and ports enabled:

1. Connect to the console port as described in [Access the Command-Line Interface over the Console Port](#).

- Wait at least two minutes after the system prompt appears, and then switch to **Configure** mode.

The GigaVUE-HCI-Plus node provides three command entry modes, each with increasingly powerful rights – **Standard**, **Enable**, and **Configure**. Module and port configuration commands are only available in Configure mode:

- Type **en <Enter>** to switch to Enable mode.

The system prompt changes from **[hostname] >** to **[hostname] #**.

- Type **config t <Enter>** to switch to Configure mode.

The system prompt changes from **[hostname] #** to **[hostname] (config) #**.

- Use the following command to check module status:

**(config) # show cards**

- Check the values in the **Config Status** and **Oper Status** columns for all modules and verify that they read **Yes** for configured and **Up** for inserted. This is your indication that the node is ready for further configuration.
- If the **Config Status** does not show **Configured** for all modules after two minutes, take the action corresponding to your **show cards** output, as follows:

show cards Output:	Corrective Action
<b>Config Status</b> does not show <b>Configured</b> for any cards (including base chassis)	<b>(config) # chassis box-id &lt;integer&gt;(config) # card all</b>
<b>Config Status</b> shows <b>Configured</b> for base chassis but not one or more modules	<b>(config) # card slot x</b> <div style="border: 1px solid black; padding: 5px; margin-top: 5px;"> <p><b>NOTE:</b> If all modules are unconfigured, you can also use the <b>card all</b> command. If some cards are already configured, however (for example, because you just installed a new card), it is better to use <b>slot x</b> for the unconfigured cards.</p> </div>

The **card** command initializes the unconfigured module. However, it can only be used after the node's box ID has been configured, as reported at the top of the **show cards** output (shown below).

- Use the **show cards** command again to verify the following:
  - Box ID** is not empty.
  - Config Status** shows **configured** for all modules.
  - Oper Status** shows **up** for all modules.

The **show cards** command output for a GigaVUE-HCI-Plus displays the properly configured modules.

```
HC1P (config) # show cards
```

Box ID: 1				
Slot	Config	Oper Status	HW Type	Product Code
Serial Num		HW Rev		
cc1	yes	up	HC1P-Main-Board	132-00GW
1GW0-006E		3.1-07		
1	yes	up	HC1P-C04X08	132-00GZ
1GZ0-006E		1.2-7		
2	yes	up	PRT-HC1-X12	132-00EK
1EK0-029C		A3-88		
3	yes	up	PRT-HC1-X12	132-00EK
1EK0-000D		2.0-88		
4	yes	up	SMT-HC1A-R	132-00GX
1GX0-007A		3.1-7		

- Use the **port** command with the **admin** argument to enable the ports on the module. For example, the following two commands enable all ports on a PRT-HC1-Q04X08 module:

```
(config) # port 1/2/x1..x8 params admin enable
```

- Save your changes so that the modules and ports come up automatically at the next reboot:

```
(config) # write memory
```

## Setting Port Parameters Manually

If autonegotiation is not enabled on the other end of the connection, you must manually configure the **port params** of the GigaVUE-HC1-Plus module port to match, followed by a **write** to save the current settings.

The **port params** commands are available in the Configure mode. The syntax is as follows:

```
port <port-list> params admin <disable | enable> autoneg <disable |
enable> discovery <cdp | lldp | all | disable> duplex
<full> forcelinkup <disable | enable> speed <10 | 100 | 1000 |
10000> taptx <active | passive>
```

The following table summarizes these options:

Argument	Description
<b>admin</b> <disable   enable>	Enables/disables ports administratively. Use the <b>show port params</b> command to see which ports are enabled and disabled. Refer to <a href="#">Setting Port Parameters Manually</a> for a summary of how this argument interacts with the <b>admin</b> argument.
<b>autoneg</b> <disable   enable>	Enables and disables autonegotiation for a port. When autonegotiation is enabled, duplex and speed settings are ignored (they are set via autonegotiation). Refer to <a href="#">Setting Port Parameters Manually</a> for a summary of how this argument interacts with the <b>admin</b> argument. Autonegotiation is always disabled for 10Gb ports.

Argument	Description
	For 1Gb speeds over copper, autonegotiation must be enabled, per the IEEE 802.3 specification. Gb optical ports cannot enable autoneg.
<b>discovery</b> <b>&lt;cdp   lldp  </b> <b>all   disable&gt;</b>	Configures port discovery options as follows: cpd—Enables CDP port discovery. lldp—Enables LLDP port discovery. all—Enables all port discovery protocols (meaning both CDP and LLDP). disable—Disables port discovery. Discovery is disabled by default. To enable discovery, configure one or more protocols.
<b>duplex &lt;full&gt;</b>	Specifies the port's duplex configuration. Only a full-duplex is supported. Starting in software version 5.2, half duplex support is removed from all GigaVUE® HC series nodes. If half duplex was configured in a previous software version, it will remain intact following the upgrade to 5.2 or higher release. Update to full duplex, if required.
<b>forcelinkup</b> <b>&lt;disable  </b> <b>enable&gt;</b>	Forces connection on an optical port. Use this option when an optical tool port is connected to a legacy optical tool that does not transmit light. Available as follows: Optical 1Gb/10Gb/25Gb tool ports Not available for 10Gb-capable ports with a 1Gb SFP installed. 10Gb-capable optical tool ports only support <b>forcelinkup</b> when a 10Gb SFP+ is installed.

## Forcelinkup and Enabling/Disabling Ports

The GigaVUE-HCI-Plus node includes **forcelinkup** and **admin** arguments for the **port params** command. The **forcelinkup** argument forces the link state on an optical tool port connected to a legacy tool that does not transmit the light required to bring the link up. The following table summarizes how traffic flows for different combinations of **port params admin** and **port params forcelinkup** applied to an optical tool port.

	<b>forcelinkup = disable</b>	<b>forcelinkup = enable</b>
<b>admin = enable</b>	No traffic passed if autonegotiation is not successful.	Traffic is passed.
<b>admin = disable</b>	No traffic passed.	No traffic passed.

# GigaVUE-HCI-Plus Specifications

This appendix provides the physical specifications, power requirements, and environmental specifications for GigaVUE-HCI-Plus nodes. Compliance with safety, emissions, and immunity is also provided.

Refer to the following sections for details:



- Physical Dimensions and Weight
- Battery Caution
- Compliance
- Power Requirements
- Environmental Specifications
- Standards and Protocols
- Warranty

## Physical Dimensions and Weight

The following table summarizes the dimensions and weight of the GigaVUE-HC1-Plus nodes and their modules:

Node	Height	Width	Depth	Weight
GigaVUE-HC1-Plus ( with built-in third-generation GigaSMART engine)	1RU 1.7 inch wide (4.32cm)	Metal to Metal 17.0 inch (43.18cm)	Metal to Metal 23.0 inch (58.4cm)	33.8lb (15.3kg)
BPS-HC1-D25A60 Bypass Module	1.6in(4.06cm)	4.65in (11.80cm)	10.13in(24.98cm)	2.2lb (0.99kg)
BPS-HC1-D35C60 Bypass Module	1.6in(4.10cm)	4.65in (11.80cm)	10.13in(24.98cm)	2.2lb (0.99kg)
SMT-HC1-S	1.6in	4.65in (11.80cm)	110.13in (24.98cm)	2.54lb (1.15kg)
PRT-HC1-Q04x08	1.6in(4.10cm)	4.65in (11.80cm)	10.13in(24.98cm)	1.4lb (0.68kg)
BPS-HC1-D25A24 Bypass Combo Module	1.6in(4.10cm)	4.65in (11.80cm)	10.13in(24.98cm)	2.2lb (0.99kg)
PRT-HC1-X12 Module	1.6in(4.10cm)	4.65in (11.80cm)	10.13in(24.98cm)	1.55lb (0.70kg)
TAP-HC1-G10040 Copper (RJ-45)4 TAP Module	1.6in(4.10cm)	4.65in (11.80cm)	10.13in(24.98cm)	1.5lb(0.68kg)

## Battery Caution

A disposable, non-rechargeable, Real Time Clock (RTC) Lithium metal coin cell battery is in the GigaVUE-HC1-Plus. Note the following:

- There is a risk of fire if the battery is replaced with an incorrect type.
- Use only CR-2032L type Lithium metal coin cell battery and replace it with the same.

## Compliance

This section provides compliance information for GigaVUE-HC1-Plus.

### Safety

GigaVUE-HC1-Plus is compliant with the following safety regulations:

- UL 60950-1, 2nd Edition
- CAN/CSA C22.2 No. 60950-1-07, 2nd Edition
- EN 60950-1:2006/A11:2009/A1:2010/A12:2011/A2:2013
- IEC 60950-1:2005 (2nd Edition) + Am 1:2009 + Am 2:2013

### Emissions

GigaVUE-HC1-Plus is compliant with the following emissions regulations:

- FCC Part 15, Class A
- VCCI Class A. Refer to [Class A Information Technology Equipment \(ITE\)](#).
- EN55022/CISPR-22 Class A
- Australia/New Zealand AS/NZS CISPR-22 Class A:RCM
- EU:CE Mark EN 55022 Class A
- CCC China
- BSMI Taiwan
- KCC Korea
- EAC Russia

## Class A Information Technology Equipment (ITE)

<p>この装置は、クラス A 情報技術装置です。この装置を家庭環境で使用すると電波妨害を引き起こすことがあります。この場合には使用者が適切な対策を講ずるよう要求されることがあります。</p> <p>VCCI-A</p>
---

Translation of Statement for Class A VCCI-certified Equipment:

This is a Class A product based on the standard of the Voluntary Control Council for Interference by Information Technology Equipment (VCCI). If this equipment is used in a domestic environment, radio disturbance may occur, in which case, the user may be required to take corrective action.

### Class A Korea Caution

The following caution applies to Korea Class A Equipment.

이 기기는 업무용(A급) 전자파적합기기로서 판매자 또는 사용자는 이 점을 주의하시기 바라며, 가정외의 지역에서 사용하는 것을 목적으로 합니다.

Translation of Caution Statement for Korea Class A Equipment:

This equipment is Industrial (Class A) electromagnetic wave suitability equipment, and the seller or user should take notice of it, and this equipment is to be used in places except for the home.

## Immunity

GigaVUE-HC1-Plus is compliant with the following immunity regulations:

- ETSI EN300 386 V1.6.1:2012
- EN61000-3-2
- EN61000-3-3
- EN61000-4-2
- EN61000-4-3
- EN61000-4-4
- EN61000-4-5
- EN61000-4-6
- EN61000-4-8
- EN61000-4-11

## Environmental

GigaVUE-HC1-Plus is compliant with the following environmental regulations:

- EU RoHS 6, EU directive 2011/65/EU
- NEBS Level 3. Refer to [NEBS Level 3 Compliance](#).

## Security

- Common Criteria (Certification pending). Refer to “Common Criteria” in the **GigaVUE-OS CLI Reference Guide**.
- FIPS 140-2. Refer to “FIPS 140-2 Compliance” in the **GigaVUE-OS CLI Reference Guide**.

## Power Requirements

The following table summarizes the electrical characteristics of GigaVUE-HC1-Plus nodes.

**NOTE:** Refer to [Connecting Power to the GigaVUE-HC1-Plus](#) for instructions on how to connect AC and DC power supply modules.

Power Specification	Specification
<b>Power Configuration</b>	1 + 1 Power: 2 Power Supply Modules
<b>Max Power Consumption/Heat Output</b>	650 Watts / 2,216 BTU/hr Fully populated system with all ports at 100% traffic load
<b>AC Power Supply Modules</b>	Min/Max Voltage: 100 to 127V AC, 200 to 240V AC, 50/60Hz Max PSM Input Current: 5.8A@100V, 2.9A@200V
<b>DC Power Supply Modules</b>	Min/Max Voltage: -40.5V to -60V DC Max PSM Input Current: 24A @ -40.5V

## Environmental Specifications

The following table summarizes the environmental specifications for GigaVUE-HC1-Plus nodes.

Specification	GigaVUE-HC1-Plus Node
<b>Operating Temperature</b>	32°F to 104°F (0°C to 40°C)
<b>Operating Relative Humidity</b>	20% to 80%, non-condensing
<b>Recommended Storage Temperature</b>	-4°F to 158°F (-20°C to 70°C)
<b>Recommended Storage Relative Humidity</b>	15% to 85%, non-condensing
<b>Altitude</b>	Up to 10,000ft (3.05km)

## Standards and Protocols

IEEE 802.3-2012, IEEE 802.1Q VLAN, IEEE 802.3 10BASE-T, IEEE 802.3u 100BASE-TX, IEEE 802.3ab 1000BASE-T, IEEE 802.3z 1000BASE-X, IEEE 802.3ae 10000BASE-X, IEEE 802.3ba, RFC 783 TFTP, RFC 791 IP, RFC 793, TCP, RFC 826 ARP, RFC 768 UDP, RFC 792 ICMP, SNMP v2c/v3, RFC 2131 DHCP client, RFC 1492 TACACS+, and support for IPv4 and IPv6.

## Warranty

Gigamon offers a range of premium support and extended services. For details regarding warranty, visit: <https://www.gigamon.com/support-and-services/warranty>

# Console Port Signaling and Cabling

This appendix provides the pin-outs for the RJ45-to-RJ45 rollover cable and RJ45-to-DB-9 adapter provided with the GigaVUE-HC1-Plus node for connections from the node's console port to a PC's COM port.

The following figure shows how to connect the RJ45-to-RJ45 rollover cable from the GigaVUE-HC1-Plus node's console port to a COM port on a PC using the RJ45-to-DB-9 adapter.

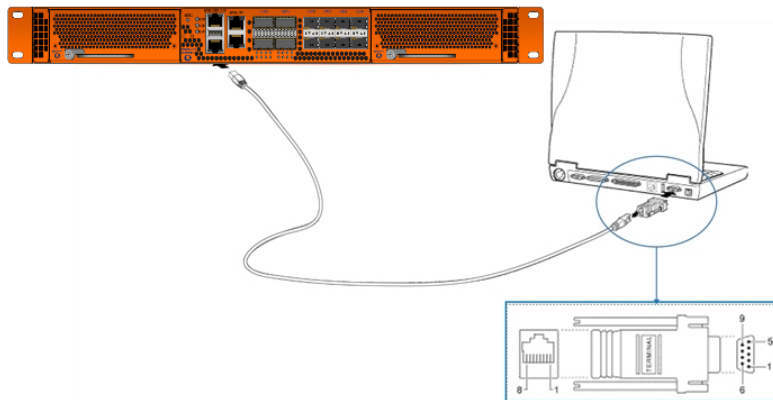

The following table lists the pinouts for this connection.

Console Port from GigaVUE-HC1-Plus RJ45 Jack	RJ45-to-RJ45 Rollover Cable		RJ45-to-DB-9 Terminal Adapter	Console Device on PC
Signal	RJ45 Pin	RJ45 Pin	DB-9 Pin	Signal
N/A	1	8	8	N/A
N/A	2	7	6	N/A
TxD	3	6	2	RxD
GND	4	5	5	GND
GND	5	4	5	GND
RxD	6	3	3	TxD
N/A	7	2	4	N/A
N/A	8	1	7	N/A

# NEBS Level 3 Compliance

This appendix provides installation instructions for GigaVUE-HC1-Plus Network Equipment-Building System (NEBS) Level 3 compliance.

## Installation Instructions GigaVUE-HC1-Plus

The following sections detail installation instructions for GigaVUE-HC1-Plus.

### Intrabuilding or Intra-connection

**WARNING:** The intra-building ports:

- BNC Coaxial PPS
- RJ45: PTP-1588, Management port, Console port, Stack port
- RJ45: 10/100/1000 ports
- HC1P-C04X08
  - 100Gb : C1-C4
  - 1Gb/10Gb/25Gb : X1-X8
- BPS-HC1-D25A60
  - BPS SX/SR (50/125µm) 6 pairs: X1 - X12
- BPS-HC1-D35C60 LX/LR
  - BPS LX/LR (50/125µm) 6 pairs: X1 - X12
- PRT-HC1-Q04x08
  - 4 40Gb/100Gb QSFP+,QSFP28
  - 1Gb/10Gb/25Gb SFP/SFP+,SFP28: X1-X8
- PRT-HC1-X12
  - 1Gb/10Gb SFP/SFP+: X1 - X12
- BPS-HC1-D25A24
  - 1Gb/10Gb SFP/SFP+: X1 - X4
  - BPS SX/SR (50/125µm) 2 pairs: X5 - X8
- TAP-HC1-G10040
  - TAP 1Gb Copper 4 pairs: G1 - G8

GigaVUE-HC1-Plus equipment or subassembly are only suitable for connection to intrabuilding or unexposed wiring or cabling. The intra-building port(s) of the equipment or subassembly **MUST NOT** be metallicity connected to interfaces that connect to the OSP or its wiring. These interfaces are designed for intra-building interfaces only (Type 2 or Type 4 ports as described in GR-1089-CORE, Issue 6) and require isolation from the exposed OSP cabling. The addition of Primary Protectors is not sufficient protection to connect these interfaces metallicity to OSP wiring.

## Intrabuilding Ports (RJ45)

**WARNING:** The intrabuilding ports (RJ45) shall be connected to shielded and grounded cables at both ends.

## Class A2 Voltage Accessibility

The GigaVUE-HCI-Plus shall be located in a restricted access location where only crafts personnel are allowed access.

## Class B Voltage Accessibility

The GigaVUE-HCI-Plus shall be located in a restricted access location where only crafts personnel are allowed access.

## Equipment Grounding Systems

The GigaVUE-HCI-Plus shall be installed and connected to the (CBN).

## Communication Equipment Grounding

The GigaVUE-HCI-Plus is suitable for connection to the (Central Office and CPE).

## Connections

- a. The GigaVUE-HCI-Plus shall be grounded via a copper ground conductor #6 AWG for CPE installation.
- b. All bare grounding connection points to the GigaVUE-HCI-Plus shall be cleaned and coated with an antioxidant solution before connections are made.
- c. All surfaces on the GigaVUE-HCI-Plus that are unplated shall be brought to a bright finish and treated with an antioxidant solution before connections are made.
- d. All non-conductive surfaces on the GigaVUE-HCI-Plus shall be removed from all threads and connection points to ensure electrical continuity.
- e. Multiple connectors shall not be secured by the same bolt assemblies.
- f. Unplated connection surfaces to be intentionally joined to form a bonding or grounding path shall be brought to a bright finish and then coated with an antioxidant before they are joined (electrical connections).
- g. Listing fastening hardware shall be compatible with materials being joined and shall preclude loosening deterioration as well as electrochemical corrosion of the hardware and joined materials.
- h. Non-conductive coatings (such as paint, lacquer, and enamel) on the equipment to be bonded or grounded shall be removed from threads and other contact surfaces to assure electrical continuity.

a GigaVUE-HCI-Plus utilizes a Spade width 0.32in/.81cm with a Standard Wire 14-16 (AWG) that utilizes 5in-lbs of torque to secure it to the frame and EUT. Only listed two-hole compression-type connectors shall be used in making connections to flat surfaces (such as bus bars, frames, racks, or cabinets). Torquing and bolts assembly requirements for securing the connector shall be as specified by the connector supplier.

## Maintenance

**CAUTION:** Remove all power sources before servicing. (TO COMPLETELY REMOVE POWER FROM THE UNIT, FIRST TURN OFF THE POWER SWITCH AND REMOVE BOTH POWER CABLES).



# Additional Sources of Information

This appendix provides additional sources of information. Refer to the following sections for details:

- [Documentation](#)
- [Documentation Feedback](#)
- [Contact Technical Support](#)
- [Contact Sales](#)
- [The VÜE Community](#)

## Documentation

This table lists all the guides provided for GigaVUE HC Series software and hardware. The first row provides an All-Documents Zip file that contains all the guides in the set for the release.

**NOTE:** In the online documentation, view [What's New](#) to access quick links to topics for each of the new features in this Release; view [Documentation Downloads](#) to download all PDFs.

Table 1: Documentation Set for Gigamon Products

GigaVUE HC Series 6.8 Hardware and Software Guides
<p><b>DID YOU KNOW?</b> If you keep all PDFs for a release in common folder, you can easily search across the doc set by opening one of the files in Acrobat and choosing <b>Edit &gt; Advanced Search</b> from the menu. This opens an interface that allows you to select a directory and search across all PDFs in a folder.</p>
<p><b>Hardware</b></p> <p>how to unpack, assemble, rackmount, connect, and initially configure ports the respective GigaVUE HC Series devices; reference information and specifications for the respective GigaVUE HC Series devices</p>
<b>GigaVUE-HC1 Hardware Installation Guide</b>
<b>GigaVUE-HC3 Hardware Installation Guide</b>
<b>GigaVUE-HC1-Plus Hardware Installation Guide</b>
<b>GigaVUE-HCT Hardware Installation Guide</b>
<b>GigaVUE-TA25 Hardware Installation Guide</b>
<b>GigaVUE-TA25E Hardware Installation Guide</b>
<b>GigaVUE-TA100 Hardware Installation Guide</b>

## GigaVUE HC Series 6.8 Hardware and Software Guides

**GigaVUE-TA200 Hardware Installation Guide**

**GigaVUE-TA200E Hardware Installation Guide**

**GigaVUE-TA400 Hardware Installation Guide**

**GigaVUE-OS Installation Guide for DELL S4112F-ON**

**G-TAP A Series 2 Installation Guide**

**GigaVUE M Series Hardware Installation Guide**

**GigaVUE-FM Hardware Appliances Guide**

### Software Installation and Upgrade Guides

**GigaVUE-FM Installation, Migration, and Upgrade Guide**

**GigaVUE-OS Upgrade Guide**

**GigaVUE V Series Migration Guide**

### Fabric Management and Administration Guides

**GigaVUE Administration Guide**

covers both GigaVUE-OS and GigaVUE-FM

**GigaVUE Fabric Management Guide**

how to install, deploy, and operate GigaVUE-FM; how to configure GigaSMART operations; covers both GigaVUE-FM and GigaVUE-OS features

### Cloud Guides

how to configure the GigaVUE Cloud Suite components and set up traffic monitoring sessions for the cloud platforms

**GigaVUE V Series Applications Guide**

**GigaVUE V Series Quick Start Guide**

**GigaVUE Cloud Suite Deployment Guide - AWS**

**GigaVUE Cloud Suite Deployment Guide - Azure**

**GigaVUE Cloud Suite Deployment Guide - OpenStack**

**GigaVUE Cloud Suite Deployment Guide - Nutanix**

**GigaVUE Cloud Suite Deployment Guide - VMware (ESXi)**

**GigaVUE Cloud Suite Deployment Guide - VMware (NSX-T)**

**GigaVUE Cloud Suite Deployment Guide - Third Party Orchestration**

**Universal Cloud TAP - Container Deployment Guide**

## GigaVUE HC Series 6.8 Hardware and Software Guides

### Gigamon Containerized Broker Deployment Guide

### GigaVUE Cloud Suite Deployment Guide - AWS Secret Regions

### GigaVUE Cloud Suite Deployment Guide - Azure Secret Regions

## Reference Guides

### GigaVUE-OS CLI Reference Guide

library of GigaVUE-OS CLI (Command Line Interface) commands used to configure and operate GigaVUE HC Series and GigaVUE TA Series devices

### GigaVUE-OS Security Hardening Guide

### GigaVUE Firewall and Security Guide

### GigaVUE Licensing Guide

### GigaVUE-OS Cabling Quick Reference Guide

guidelines for the different types of cables used to connect Gigamon devices

### GigaVUE-OS Compatibility and Interoperability Matrix

compatibility information and interoperability requirements for Gigamon devices

### GigaVUE-FM REST API Reference in GigaVUE-FM User's Guide

samples uses of the GigaVUE-FM Application Program Interfaces (APIs)

### Factory Reset Guidelines for GigaVUE-FM and GigaVUE-OS Devices

Sanitization guidelines for GigaVUE Fabric Management Guide and GigaVUE-OS devices.

## Release Notes

### GigaVUE-OS, GigaVUE-FM, GigaVUE-VM, G-TAP A Series, and GigaVUE Cloud Suite Release Notes

new features, resolved issues, and known issues in this release ;  
important notes regarding installing and upgrading to this release

**NOTE:** Release Notes are not included in the online documentation.

**NOTE:** Registered Customers can log in to [My Gigamon](#) to download the Software and Release Notes from the Software and Docs page on to [My Gigamon](#). Refer to [How to Download Software and Release Notes from My Gigamon](#).

## In-Product Help

### GigaVUE-FM Online Help

how to install, deploy, and operate GigaVUE-FM.

## How to Download Software and Release Notes from My Gigamon

Registered Customers can download software and corresponding Release Notes documents from the **Software & Release Notes** page on to [My Gigamon](#). Use the My Gigamon Software & Docs page to download:

- Gigamon Software installation and upgrade images,
- Release Notes for Gigamon Software, or
- Older versions of PDFs (pre-v5.7).

### To download release-specific software, release notes, or older PDFs:

1. Log in to [My Gigamon](#).
2. Click on the **Software & Release Notes** link.
3. Use the **Product** and **Release** filters to find documentation for the current release. For example, select Product: "GigaVUE-FM" and Release: "5.6," enter "pdf" in the search box, and then click **GO** to view all PDF documentation for GigaVUE-FM 5.6.xx.

**NOTE:** My Gigamon is available to registered customers only. Newer documentation PDFs, with the exception of release notes, are all available through the publicly available online documentation.

## Documentation Feedback

We are continuously improving our documentation to make it more accessible while maintaining accuracy and ease of use. Your feedback helps us to improve. To provide feedback and report issues in our documentation, send an email to:

[documentationfeedback@gigamon.com](mailto:documentationfeedback@gigamon.com)

Please provide the following information in the email to help us identify and resolve the issue. Copy and paste this form into your email, complete it as able, and send. We will respond as soon as possible.

Documentation Feedback Form		
About You	Your Name	
	Your Role	
	Your Company	

<b>For Online Topics</b>	<b>Online doc link</b>	<i>(URL for where the issue is)</i>
	<b>Topic Heading</b>	<i>(if it's a long topic, please provide the heading of the section where the issue is)</i>
<b>For PDF Topics</b>	<b>Document Title</b>	<i>(shown on the cover page or in page header )</i>
	<b>Product Version</b>	<i>(shown on the cover page)</i>
	<b>Document Version</b>	<i>(shown on the cover page)</i>
	<b>Chapter Heading</b>	<i>(shown in footer)</i>
	<b>PDF page #</b>	<i>(shown in footer)</i>
<b>How can we improve?</b>	<b>Describe the issue</b>	<i>Describe the error or issue in the documentation. (If it helps, attach an image to show the issue.)</i>
	<b>How can we improve the content?</b> <b>Be as specific as possible.</b>	
	<b>Any other comments?</b>	

## Contact Technical Support

For information about Technical Support: Go to **Settings**  **> Support > Contact Support** in GigaVUE-FM.

You can also refer to <https://www.gigamon.com/support-and-services/contact-support> for Technical Support hours and contact information.

Email Technical Support at [support@gigamon.com](mailto:support@gigamon.com).

# Contact Sales

Use the following information to Gigamon channel partner or Gigamon sales representatives.

**Telephone:** +1.408.831.4025

**Sales:** [inside.sales@gigamon.com](mailto:inside.sales@gigamon.com)

**Partners:** [www.gigamon.com/partners.html](http://www.gigamon.com/partners.html)

# Premium Support

Email Gigamon at [inside.sales@gigamon.com](mailto:inside.sales@gigamon.com) for information on purchasing 24x7 Premium Support. Premium Support entitles you to round-the-clock phone support with a dedicated Support Engineer every day of the week.

# The VÜE Community

The [VÜE Community](#) is a technical site where Gigamon users, partners, security and network professionals and Gigamon employees come together to share knowledge and expertise, ask questions, build their network and learn about best practices for Gigamon products.

Visit the VÜE Community site to:

- Find knowledge base articles and documentation
- Ask and answer questions and learn best practices from other members.
- Join special-interest groups to have focused collaboration around a technology, use-case, vertical market or beta release
- Take online learning lessons and tutorials to broaden your knowledge of Gigamon products.
- Open support tickets (Customers only)
- Download the latest product updates and documentation (Customers only)

The VÜE Community is a great way to get answers fast, learn from experts and collaborate directly with other members around your areas of interest.

**Register today at** [community.gigamon.com](http://community.gigamon.com)

**Questions?** Contact our Community team at [community@gigamon.com](mailto:community@gigamon.com).

# Glossary

## D

---

### decrypt list

need to decrypt (formerly blacklist)

### decryptlist

need to decrypt - CLI Command (formerly blacklist)

### drop list

selective forwarding - drop (formerly blacklist)

## F

---

### forward list

selective forwarding - forward (formerly whitelist)

## L

---

### leader

leader in clustering node relationship (formerly master)

## M

---

### member node

follower in clustering node relationship (formerly slave or non-master)

## N

---

### no-decrypt list

no need to decrypt (formerly whitelist)

**nodecryptlist**

no need to decrypt- CLI Command (formerly whitelist)

**P**

---

**primary source**

root timing; transmits sync info to clocks in its network segment (formerly grandmaster)

**R**

---

**receiver**

follower in a bidirectional clock relationship (formerly slave)

**S**

---

**source**

leader in a bidirectional clock relationship (formerly master)